



AXON

TASER X2

AXON Academy | TASER Training

TASER X2 Conducted Energy Weapon (CEW) – User Course

Version 21 - Effective January 14, 2019



Goal

To provide the basic operational theory and practical training to reasonably, safely and effectively operate TASER Conducted Energy Weapons (CEWs).

Course Objectives

Upon completion of this course, you will be able to:

- Explain the technology associated with X2
- Describe the nomenclature and operation of the X2
- Describe the nomenclature and operation of the TASER Smart Cartridge
- Explain proper care and troubleshooting techniques
- Explain CEW Smart Use Considerations
- Explain the Tactical Considerations associated with CEW use
- Explain proper probe placement and aiming requirements
- Demonstrate safe handling of CEWs

Training Version 21

With the release of Version 21, all prior TASER Training materials and Training Bulletins are superseded and rendered obsolete.

Release and Warning Requirements

- **Warning Acknowledgement:**
All students attending TASER User and Instructor certification courses will be required to **acknowledge** that they have read and understand the warnings prior to participating in any hands-on CEW drills required by the certification course.
- Updated copies of Version 21 documents can be found on the Training Resource page at <https://www.axon.com/training/resources>

License Agreement

All TASER Training materials/documents are copyrighted and:

- Must be used in their entirety (PowerPoint® slides, video, and instructor notes)
- May only be used by TASER Training certified instructors holding a current certification on the CEW model being taught
- **May not be used for commercial purpose**

If you access or use TASER's Training materials, you accept and agree to be bound by Axon's License Agreement.

Program Requirements

Instructor ***MUST*** ensure program includes ***only*** the most current version 21 training materials:

- PowerPoint® version of training program
- Training Bulletins and Annual Updates
- Product Warnings
- CEW Product Manuals
- TASER Instructor and User: Warnings, Risks & Release Agreement (“Release”)

Disclaimers

- TASER Training (provided by Axon Enterprise) does NOT set use of force policies, general orders, or procedures.
- TASER Training does not give legal advice and nothing contained in these training materials creates any form of attorney-client relationship. Be sure to consult with your local legal advisors for any legal advice, guidance, or direction.
- TASER Training materials may include videos or other information from outside sources to facilitate discussion. The inclusion of such materials is not an endorsement of the procedures or tactics depicted.

Disclaimers

- Each agency is responsible for creating its own use of force policies and procedures.
- Use of force policy should address CEW use, and should be communicated to all officers.
- TASER CEWs are serious weapons and should be treated as such at all times.
- TASER CEWs are not a substitute for authorized deadly force.

Safety Rules

- **No live firearms in training area**
- **Every participant is responsible for immediately reporting any safety issues.** If an unsafe condition occurs or is noticed during an exercise, the student or instructor observing the unsafe condition will call **“STOP ACTION!”**
- One student or instructor will be designated as the safety officer during each exposure, live fire and practical exercise/scenario*
- All activity will stop when any student or instructor calls **“STOP ACTION!”**

Safety Rules

- Protective eyewear **MUST** be worn at all times during any weapons handling—including during exposures
- The safety switch on all TASER CEWs will remain in the down (SAFE) position unless the instructor directs students to arm the CEW or when it is appropriate to do so during a training drill
- TASER CEWs must not be pointed at any person or body part unless the instructor directs students to do so as part of a training exercise or scenario

Safety Rules

- A TASER CEW loaded with a live cartridge must not be pointed at another person or body part except during voluntary exposures
- During training scenarios, only use:
 - ▣ Blue LS cartridges with simulation suit
- LASERs must not be pointed at eyes
- Probes must be removed according to proper protocol

TASER CEWS ARE NOT RISK FREE

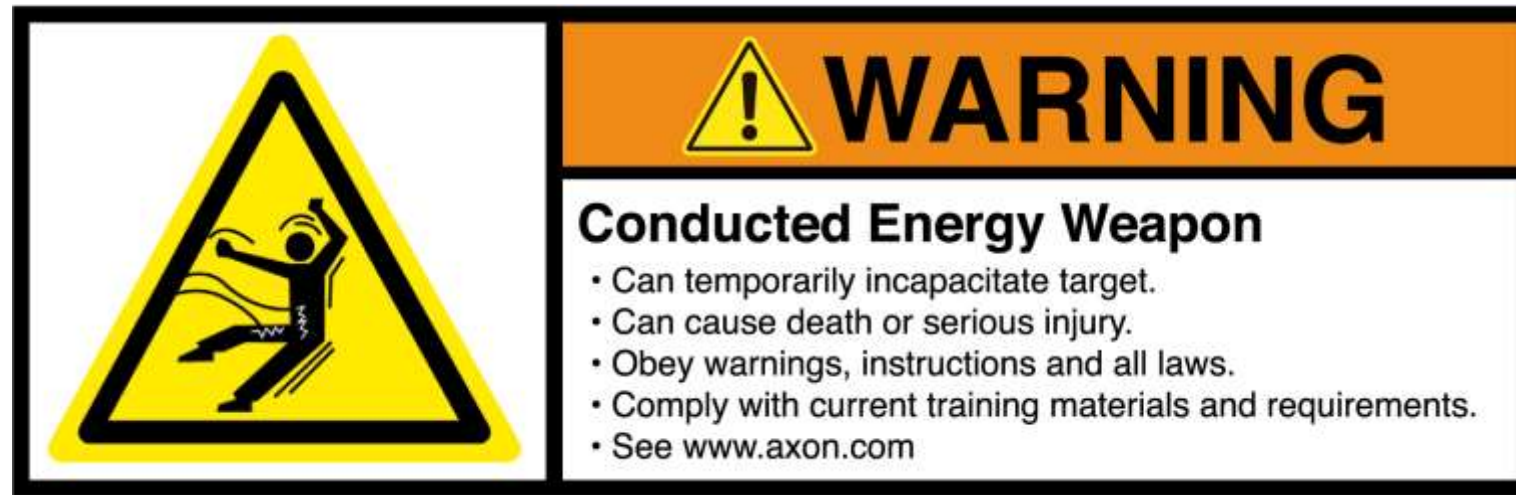

REVIEW AND UNDERSTAND TASER CURRENT PRODUCT WARNINGS



Brief Overview of CEW Technology





Arcing Probes

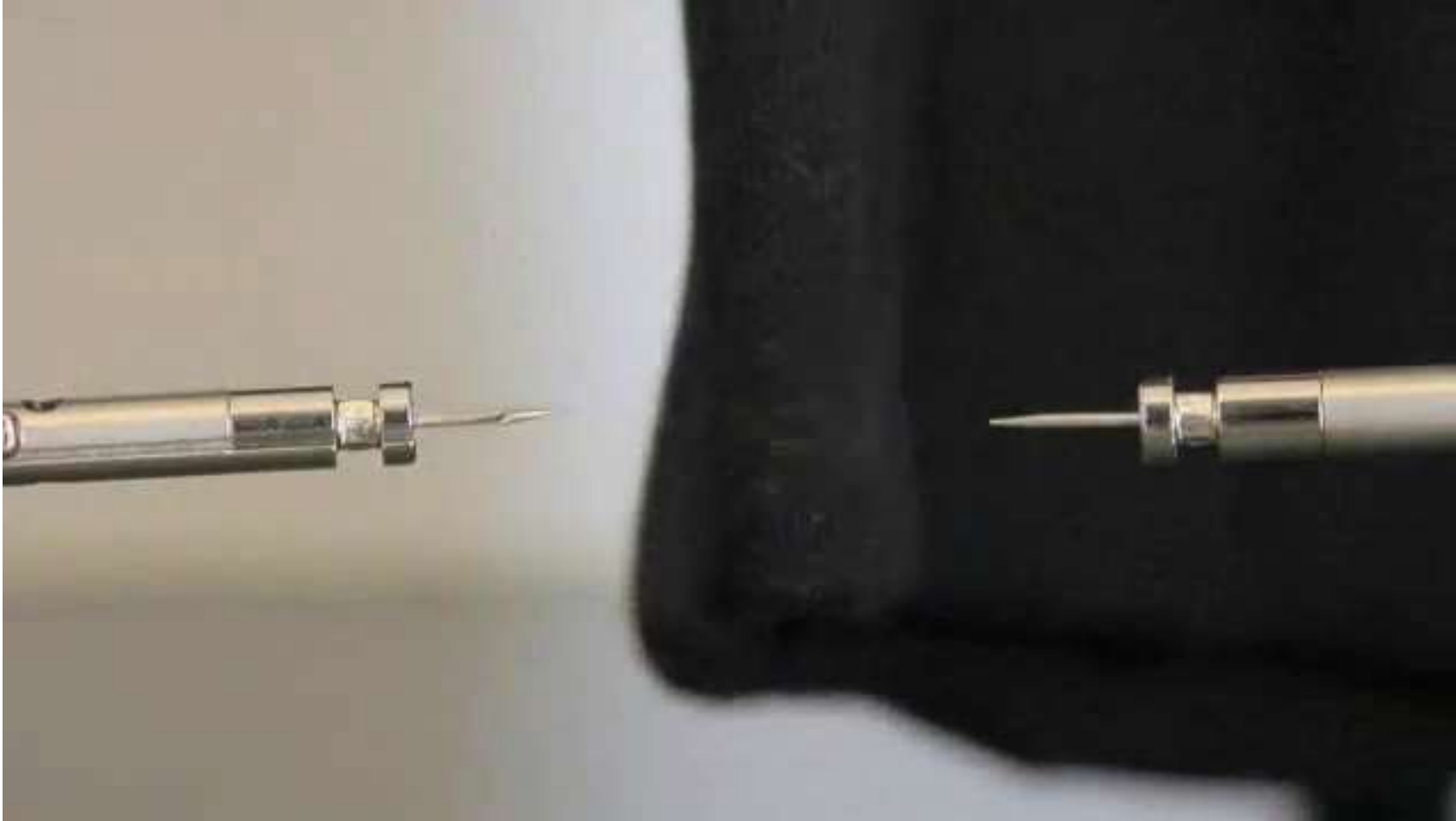



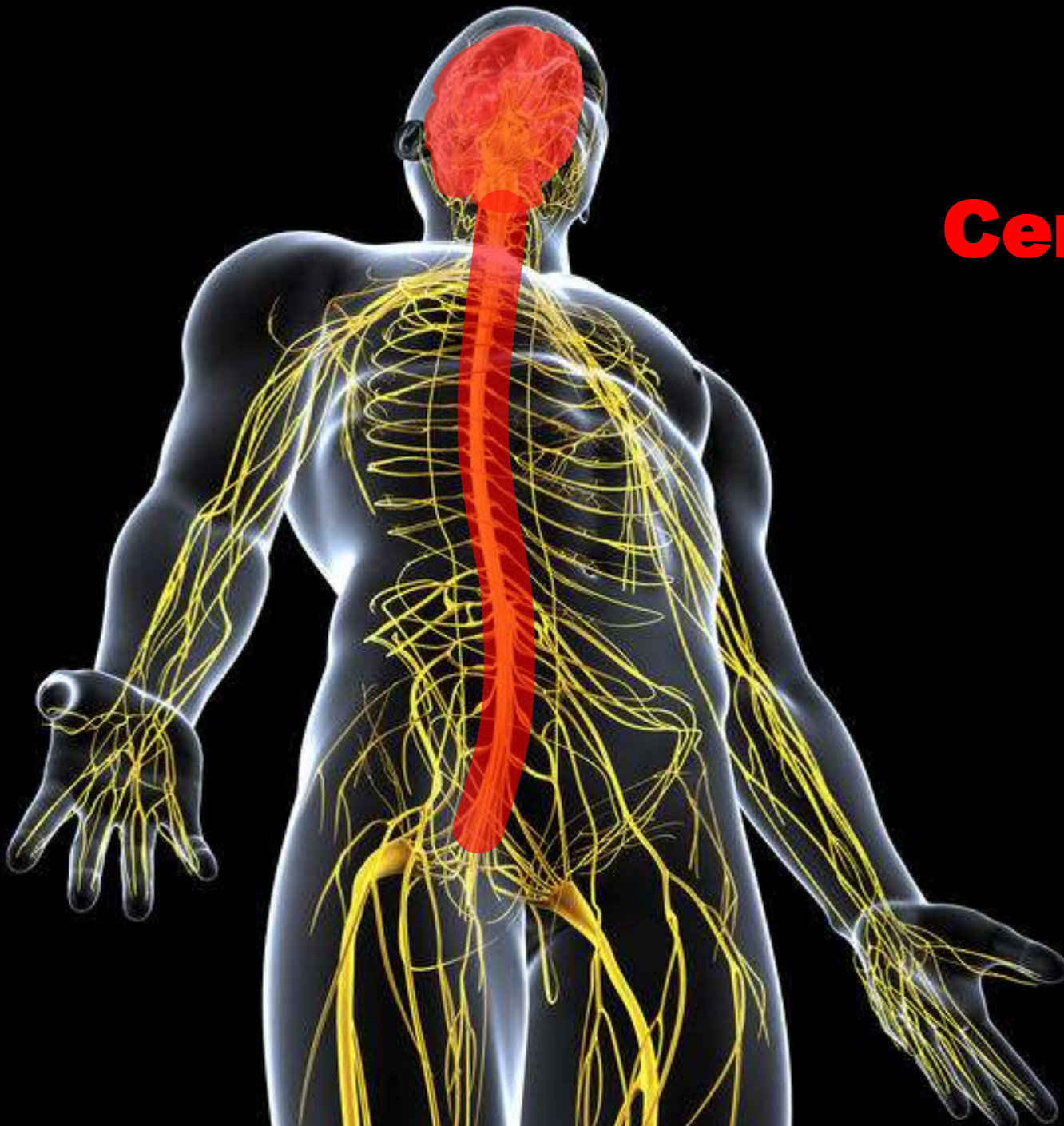

Central Nervous System

Includes the brain and spinal cord

The command center where information is processed, decisions are made, and information is stored.

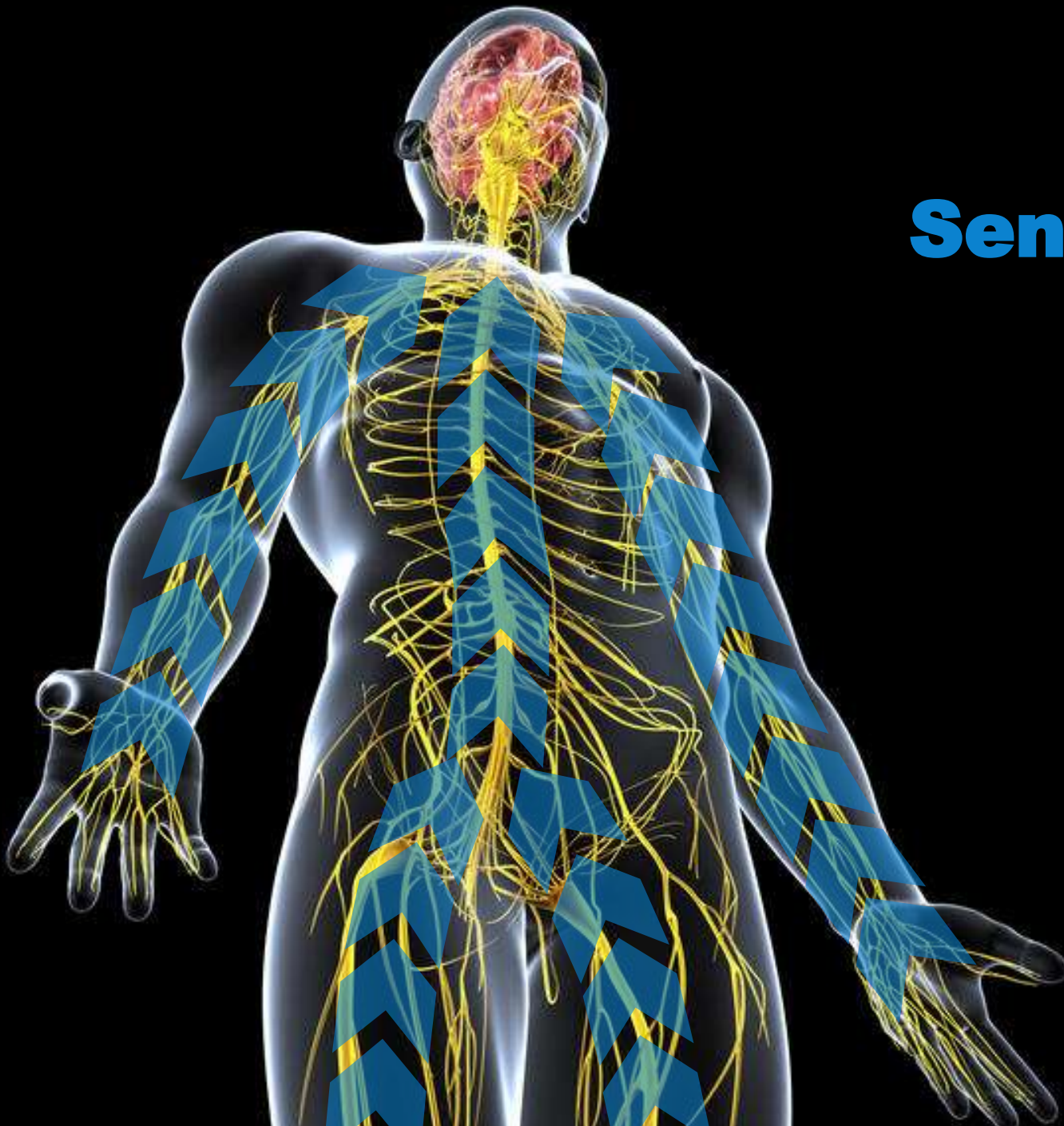

Sensory Nervous System

Brings information into the brain.

Consists of the nerves that connect the sensors of the body (eyes, ears, skin, etc.) to the brain.

Early stun devices primarily stimulated the sensory nervous system, causing pain but not stopping truly motivated subjects.



Motor Nervous System

Carries commands from the brain to the body's muscles

Consists of the nerves that go out from the spinal cord and connect to the muscles controlling muscle movements.

NMI systems affect BOTH the sensory and motor nerves

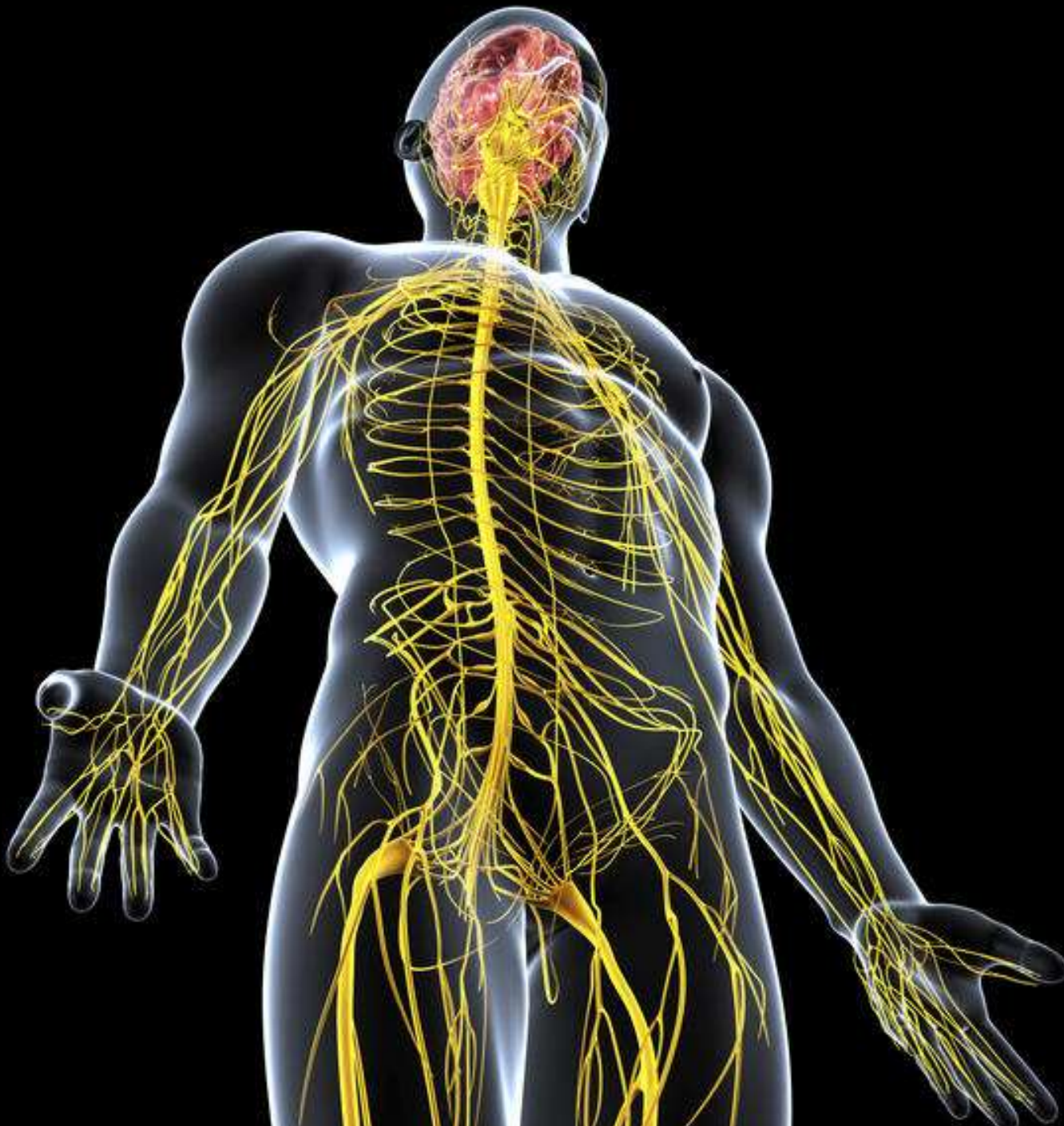

NEURO-MUSCULAR INCAPACITATION

Causes uncontrollable muscle contractions and reduced ability to perform voluntary movements.

Accomplished by delivering electrical pulses across two electrodes to over stimulate the motor nerves.

SPREAD OF ELECTRODES IS KEY:



Neuro-Muscular Incapacitation

- There are different levels of Neuro-Muscular Incapacitation (NMI) ranging from limited area effects to significant body lockup
- [REDACTED]
- CEWs may not achieve total NMI
- Subject may maintain muscle control, particularly in arms and legs, depending on many factors including probe locations
- [REDACTED]
- [REDACTED]



Voluntary Exposures



Voluntary Exposure

- TASER Training does **NOT** require a CEW exposure for instructor or user certification
- Voluntary CEW exposure is each agency's sole and exclusive decision
- Voluntary CEW exposures must only be conducted by a currently certified TASER Instructor adhering to TASER Training
- Group CEW exposures are prohibited

Voluntary Exposure

- CEW probe exposures involve strong muscle contractions and physical exertion similar to strenuous athletic activities. Risks of injury from stress, physical exertion, falling, etc. while low, are not zero (see full warnings)
- Notify instructor verbally and in writing on RELEASE form of any pre-existing injuries, medical conditions, or individual susceptibilities
- **All volunteers must review the current TASER warnings and complete the RELEASE prior to any exposure**

Voluntary Exposure Release Form Retention

Each law enforcement agency or employer of the volunteer receiving the CEW exposure is tasked with retaining the original release as part of its training records for the duration of the student's employment with the agency. These records should not be sent to Axon Enterprise.

Voluntary Exposure

BENEFITS

- Instructor credibility as a leader and subject matter expert
- Officers can better understand the effects of the CEW
 - For deployment
 - Confidence to go “hands-on” without receiving shock
 - Self-defense
 - Court expertise
 - Secondary exposures

RISKS

- Stress, anxiety, panic
 - Exertion and effects
 - Strong muscle contractions and effects
 - Discomfort or painful experience
 - Significant injuries have occurred
- (SEE FULL WARNINGS)**

Voluntary Exposure Guidelines

- Eye protection is required for the spotters, volunteer, and anyone within the training area if probes are fired in lieu of attaching spent wires or alligator clips
- Probes shall be deployed from behind the volunteer (avoids face, throat, genitals, breasts, chest or area of the heart)
- Properly supported by two spotters to prevent falls, or placed face down on the mat prior to exposure
- Realistic field probe placements only

Voluntary Exposure Guidelines

Each spotter should hold an upper arm of the standing volunteer under the armpit, so that:

- The shoulder, arm, elbow, and wrist are stabilized close to the body to prevent stress/tension on the joints
- The volunteer can be safely supported and lowered to the ground after being hit without twisting, rotating, or putting undue stress on the arm or shoulder; or flailing/jerking forward after discharge

Voluntary Exposure Guidelines

- Proper matting
- Clear area of bystanders and objects
- Make area safe
- Careful probe removal using proper protocols

Subjects with pre-existing injuries, medical conditions, or individual susceptibilities should avoid CEW exposure or areas of concern

WARNING: FAILURE TO FOLLOW SAFETY PROCEDURES INCREASES THE RISK OF INJURY

Voluntary Exposure Training Guidelines

- Utilize probe hits to allow students to remove probes
- Target different parts of the body to show different effects

- [REDACTED]

- [REDACTED]

Voluntary Exposure WARM-UP

Prior to receiving a CEW exposure, volunteers SHALL stretch and warm-up as before exercising or athletics.

- Back
- Shoulders
- Arms
- Legs
- Torso

X2 Double Cartridge Exposure





Safety Considerations



Review TASER's CEW Research Index and other documents and materials on Axon's website

Key Safety Guidelines

1. Avoid Dangerous Falls

2. [REDACTED]

3. Use Preferred Target Zones

4. [REDACTED] – Avoid Prolonged Exposures

5. Use Caution with Sensitive Populations

1. Avoid Dangerous Falls (when practicable)



LiveLeak - glorydays31

2.

**NEW
YORK
POST**



3. Use Preferred Target Zones: Rear (when practicable)

Below neck (green zone)

- Large muscles
- Avoid head and neck

The back is the most preferred target area when reasonably practicable because it contains larger muscle groups and reduces risk of hitting sensitive body areas



3. Use Preferred Target Zones: Front (when practicable)

Lower torso (green zone below chest)

- More effective than hitting the chest
 - Larger muscles (legs)
 - Split the beltline
- Reduces risk of hitting sensitive body areas (see product warnings)
- Increases dart-to-heart safety margin distances
- Do not intentionally target head, eyes, throat, chest or genitals

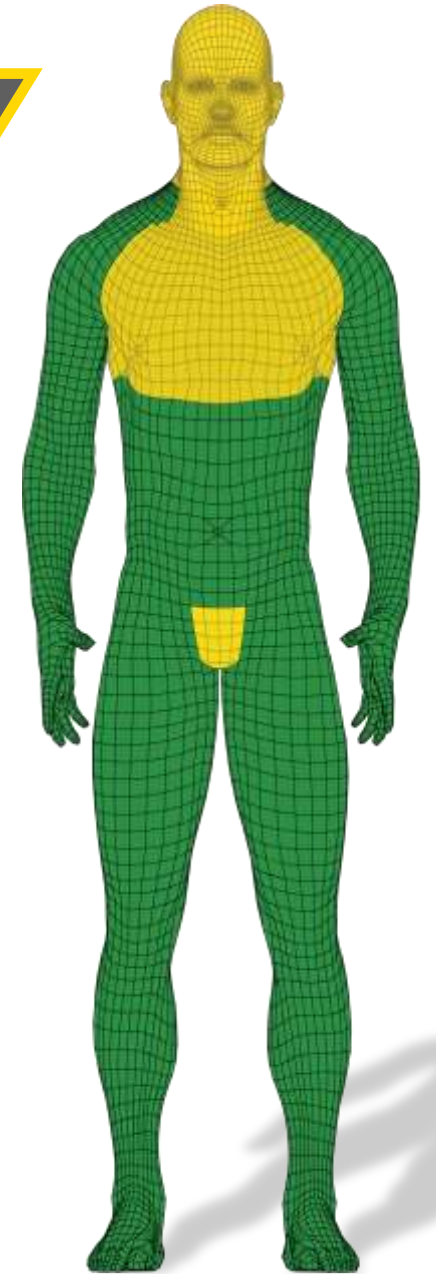

3. Use Preferred Target Zones: Front (when practicable)

CEW cardiac risks are low, but not zero

To reduce cardiac risks (when practicable):

- Target the back
- Avoid targeting the chest
- Avoid heart region
- Avoid repeated or continuous exposures

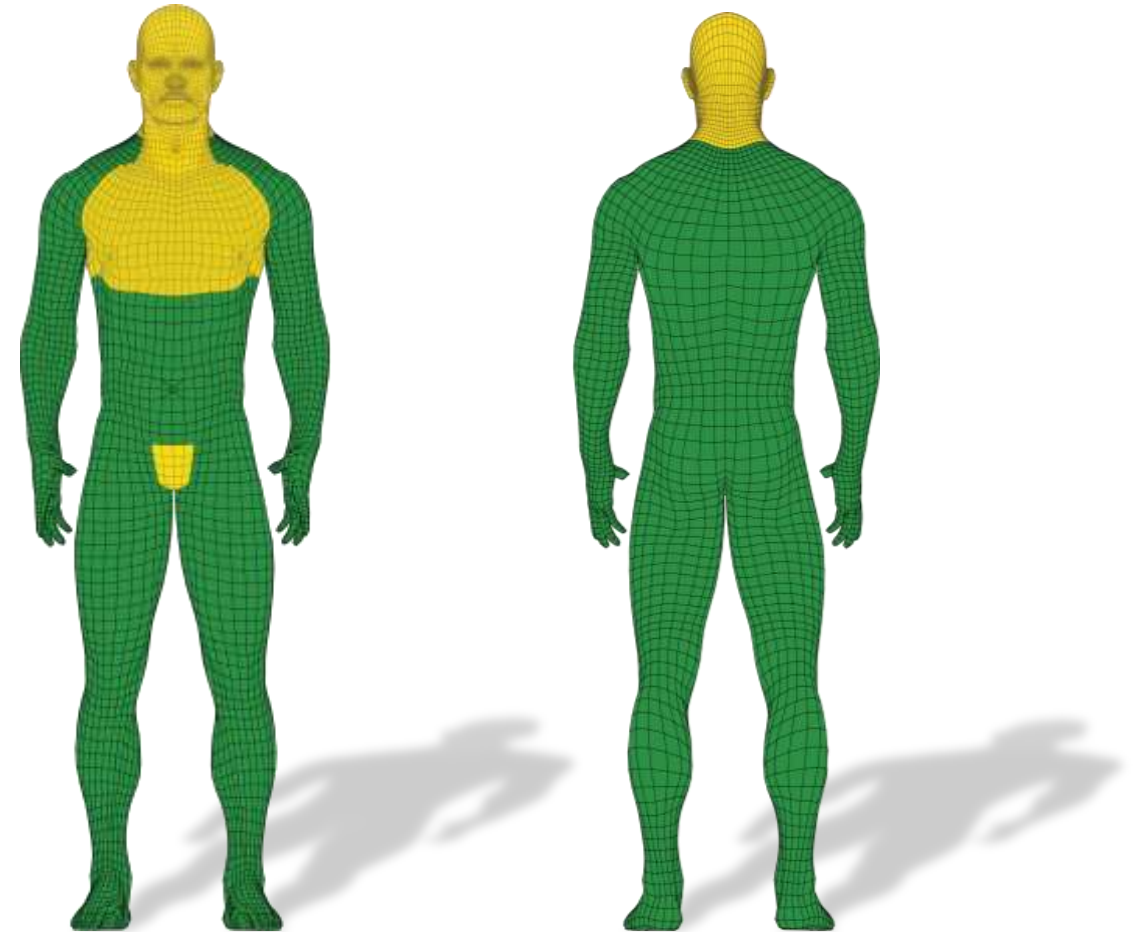

4. Restrain Fast

– Avoid Prolonged Exposures

- 
- Long or multiple CEW applications extend stress, pain, and metabolic effects
- You need to be able to clearly justify each activation or continuous activation

Physiologic/Metabolic Effects

CEWs may produce effects that could increase the risk of sudden death, including changes in:

- Blood chemistry
- Blood pressure
- Respiration
- Heart rate and rhythm
- Adrenaline and stress hormones

The longer the CEW exposure, the greater the potential effects. Use reasonable efforts to minimize the number and duration of CEW exposures

Physiologic/Metabolic Effects

Studies show CEW effects are usually comparable to or less than:

- Fighting
- Fleeing

Numerous human studies have shown lower CEW effects on human physiology compared to some other force options

5. Use Caution with Sensitive Populations



Pregnant



Children &
Minors



Elderly

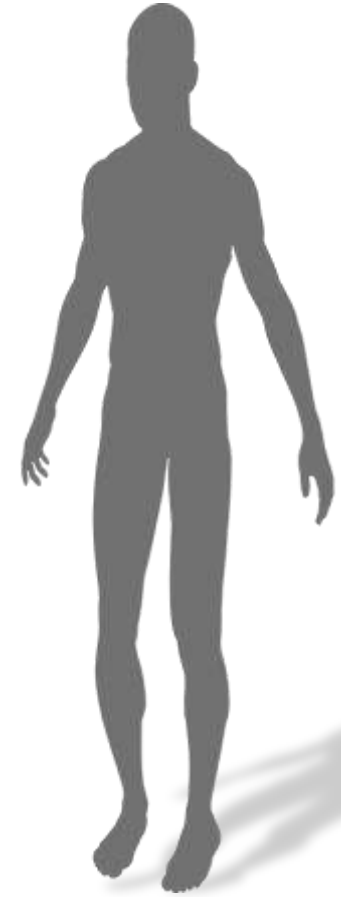

Sickly / Low Body Mass

Higher Risk Populations

CEWs, like other force options, have not been laboratory tested on:

- Pregnant women
- Elderly
- Small children
- Low body-mass index / very thin persons

CEW use on these individuals could increase the risk of death or serious injury

Medically Compromised Persons

- Any law enforcement use of force, including a CEW, may cause or contribute to death or serious injury
- Law enforcement personnel are called upon to deal with individuals in crisis that are often medically compromised and who may be susceptible to arrest-related death
- The subject may already be at risk of death or serious injury as a result of pre-existing conditions, individual susceptibilities, or other factors
- **Follow your agency's guidance and policies when dealing with medically compromised persons**

RECAP: Key Safety Guidelines

1. Avoid Dangerous Falls

2. [REDACTED]

3. Use Preferred Target Zones

4. [REDACTED] – Avoid Prolonged Exposures

5. Use Caution with Sensitive Populations



Functionality Test



Functionality Test

- A full 5-second Functionality Test should be conducted once every 24 hours or prior to the start of your shift for individually issued X2 to:
 - Check that the X2 is sparking
 - Check battery performance
 - Check CID to ensure there are no fault icons
- Be aware of potential stress memory concerns of deactivating CEW in field use too quickly

Major Fault Icon

SYMPTOM

- CID shows a major fault icon

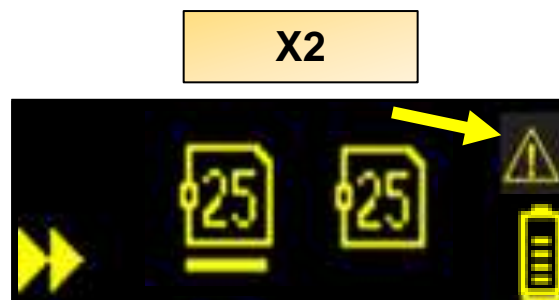

DIAGNOSTIC STEPS

- The X2 detected a fault in the ability to properly log firing events.
- Connect the CEW to Evidence Sync to synchronize the internal clock and check for firmware updates.
- Return the X2 via RMA noting “Major Fault” in the description if the issue remains.

Critical Fault Icon

SYMPTOM

- CID shows a critical fault icon

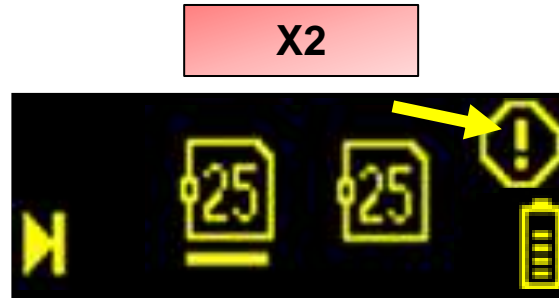

DIAGNOSTIC STEPS

- The X2 detected a problem with the communication with the High Voltage Module, or the Cartridge Illumination Module.
- As a result, the X2 will not function and must be returned via the RMA process noting “Critical Fault” as the description.

CID Smart Cartridge Icons

Cartridge
selected



Cartridge bay
empty



Cartridge
deployed



Cartridge
Sense Fault

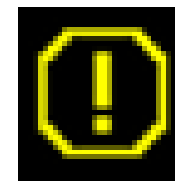

Live Simulator
(LS) cartridge



CID - Power Source Status Icons

- Reads the battery consumption and displays the remaining battery life on the CID
- PPMs should be changed at $\leq 20\%$
- TASER CAM HD should be charged at $\leq 40\%$
- Bars in battery show 20% increments



Battery
99%



Battery
80%



Battery
60%



Battery
40%



Battery
20%



Battery
0%
(Blinking)



Invalid PPM
(Blinking)

TASER X2

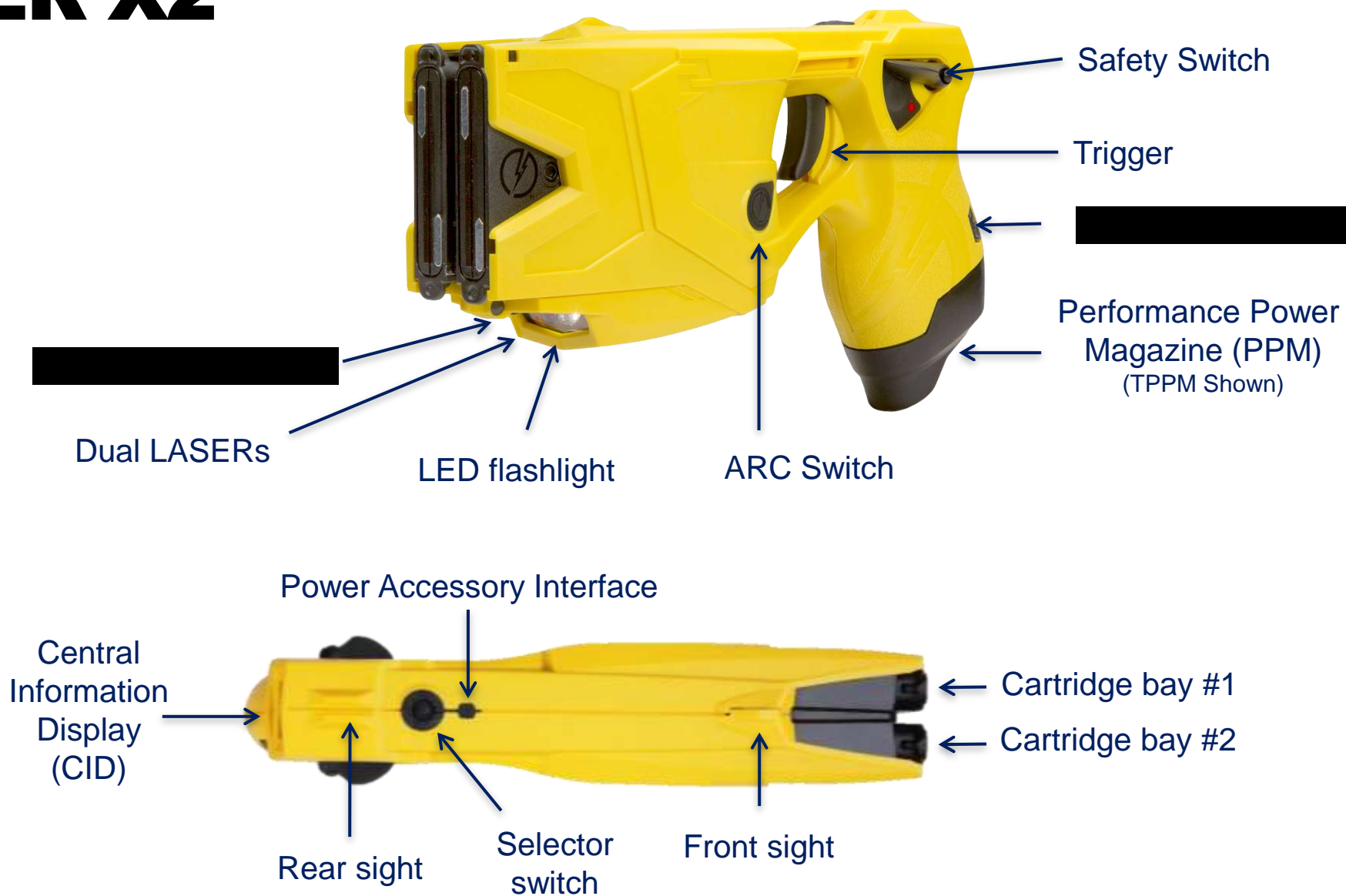

Dual LASERs

- The top LASER shows approximate point of impact of top dart. Bottom LASER shows approximate point of impact of bottom dart (15 & 25-foot cartridges only)
- When the X2 is loaded with a 15' or 25' cartridge, the bottom LASER will blink to differentiate between the top probe and bottom probe impact sites (e.g. horizontal or canted shots)

X2 CEW: Safety Switch

- Safety Switch Down
 - (SAFE)
- Safety Switch Up
 - (ARMED)
 - Activates CID, LASER and illumination
 - Begins events in the Event log

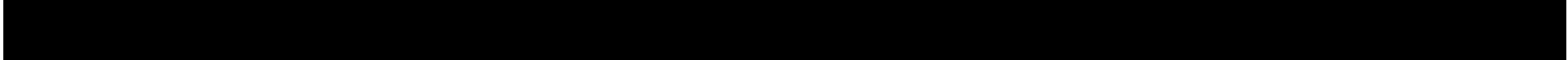

X2 Safety Switch

- The ambidextrous safety switches do not operate independently of each other
- Do not block the safety switch on the side of the X2 while attempting to move it on the other side.
 - 
- The safety switch does not need to move very far to arm the X2
- It is highly recommended that the X2 be kept in a holster that engages the safety switch when not in use



WARNING ARC

ARC SWITCH

Warning Arc

A sustained press of the ARC switch will initiate a rotational warning arc across both bays without deploying the Smart cartridges (This may be used for de-escalation purposes)

X2 CEW Trigger Operation

- Single trigger pull and release discharges an electrical charge for a 5-second cycle
- Shift the safety switch down (SAFE) to stop a discharge (e.g., if accidentally discharged)
- Holding the trigger continuously beyond the 5-second cycle will continue the electrical discharge until the trigger is released (unless using an APPM)

Semi Automatic Trigger Operation

- Once a cartridge is deployed and the trigger is released, the X2 immediately selects the next live cartridge
- A second trigger pull will deploy the second live cartridge

Semi Automatic Demonstration

Video Learning Points

- X2 Operator intentionally misses with the bottom probe during a voluntary exposure
- Corrective action is simply to pull the trigger again and deploy the second cartridge from the X2 CEW



Manual Mode Trigger Operation

- Agencies can reprogram their X2s to manual mode via Axon Evidence (Evidence.com)
- In manual mode:
 - The X2 does not automatically advance to the next cartridge
 - If the X2 is not manually advanced to the next cartridge, a second trigger pull will re-energize the previously deployed cartridge
- To advance to the next cartridge quickly press the ARC switch for a quarter of a second and release
- A trigger pull will now deploy the second cartridge

Know Your CEW Trigger Operation

Continuous Discharge

- Remember if you hold the trigger back the X2 will continue to discharge after the 5-second cycle until you release the trigger as long as there is sufficient battery charge (does not apply to X2 with APPM)
- Holding the trigger back may result in repeated or continuous CEW discharges, allegations of excessive force, and increased potential for subject injury

Independent Cycles

- Pulling the trigger only affects the selected cartridge
 - Firing a second cartridge does NOT re-energize the previously deployed cartridge
- Sustained press of ARC switch will energize both bays (cartridges) until ARC switch is released*

Re-Energizing Cartridges

- Once both cartridges are deployed, the operator can select between deployed cartridges by tapping the ARC Switch
- Pulling the trigger again will re-energize the selected cartridge for a 5-second cycle, or longer if the trigger is held down unless the X2 has an APPM
- A sustained press of the ARC Switch will re-energize both deployed cartridges

CID - Selecting Cartridges

- With the safety switch in the up (ARMED) position, a quick quarter of a second tap of the ARC switch will toggle between the two Smart cartridges
- The CID will display the cartridge selector icon toggling between the cartridges



Cartridge selector icon

Display Counts Up

- Display counts up 1,2,3,4,5 (for single trigger pull)
- Will continue to count up (6,7,8...) if the trigger is held past the 5-second cycle

Icon showing a live cartridge still available while first cartridge is counting up during cycle

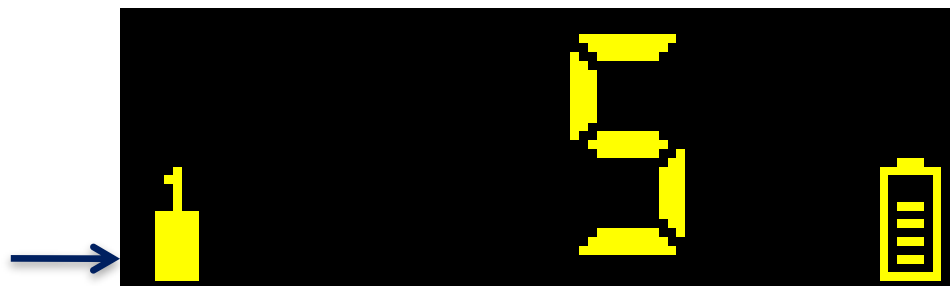

Selector Switch

- Used to access the features and options menu
- Access the options menu by pressing the selector switch
- Use only your finger to depress the selector switch
- Safety switch must be in the down (SAFE) position
- Right ARC switch scrolls through options
- Left ARC switch selects highlighted option

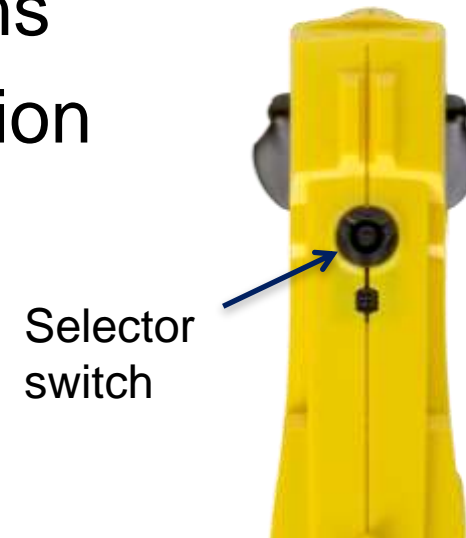

Performance Power Magazine (PPM)



SPPM



PPM



APPM



TPPM



TASER CAM HD

PPM Replacement

1.



2.

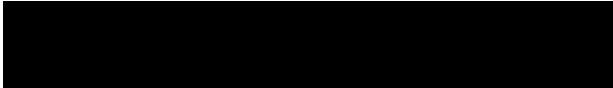

3.

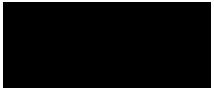
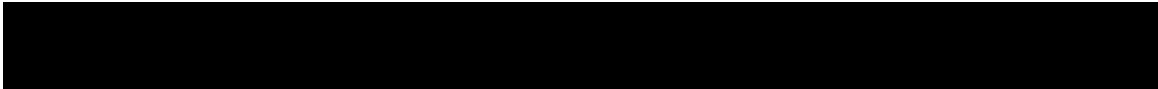

4.

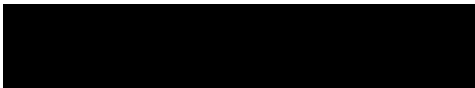
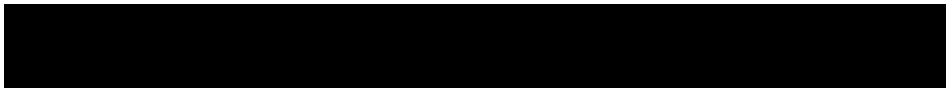

Rotational Pulse Drive™

The Rotational Pulse Drive quickly sequences discharges across both cartridge bays at a rate of approximately 19 pulses per second in each bay. It has the ability to incapacitate 2 individuals simultaneously but was primarily designed to give the operator an immediate back up shot in case of a miss or ineffective deployment.



Independent Fire Control System

The high voltage discharge and the cartridge firing method are completely separate allowing the operator to display a warning arc without firing cartridges

Cross Connect

- The X2's two shot capability is intended to provide an immediate back-up shot if the first shot misses or is ineffective
- Cartridge bays operate independently and will not energize at the same time
- While the X2 can be used on two suspects at the same time, this involves the use of fine motor skills that need to be addressed in training to manage discontinuation of force if one subject becomes compliant

Cross Connect

Cross connect technology was designed to account for a missed, incomplete or ineffective first shot

Any Combination
of Top & Bottom Darts
Completes Circuit

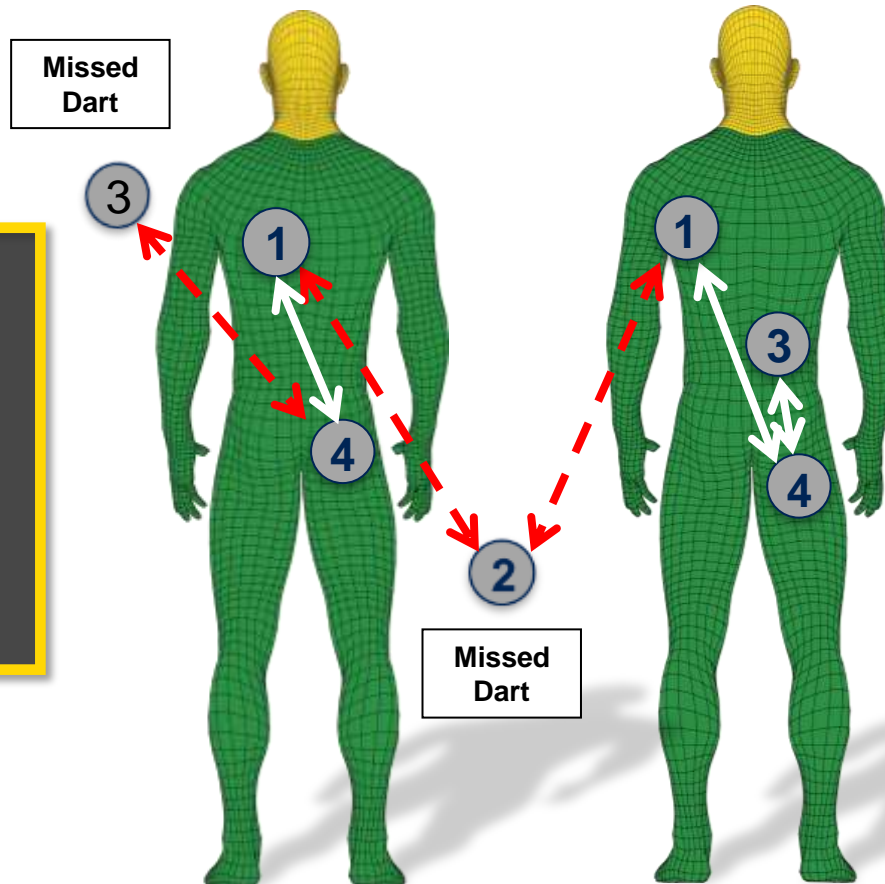

3 Dart Combination
More Effective
Spread



Cross Connect

Both bays can be deployed if an officer is unable to create enough distance for an effective probe spread

1-2 and 3-4 will have the best connection

There may be some residual current between 2-3 or 1-4 but not likely to cause NMI.

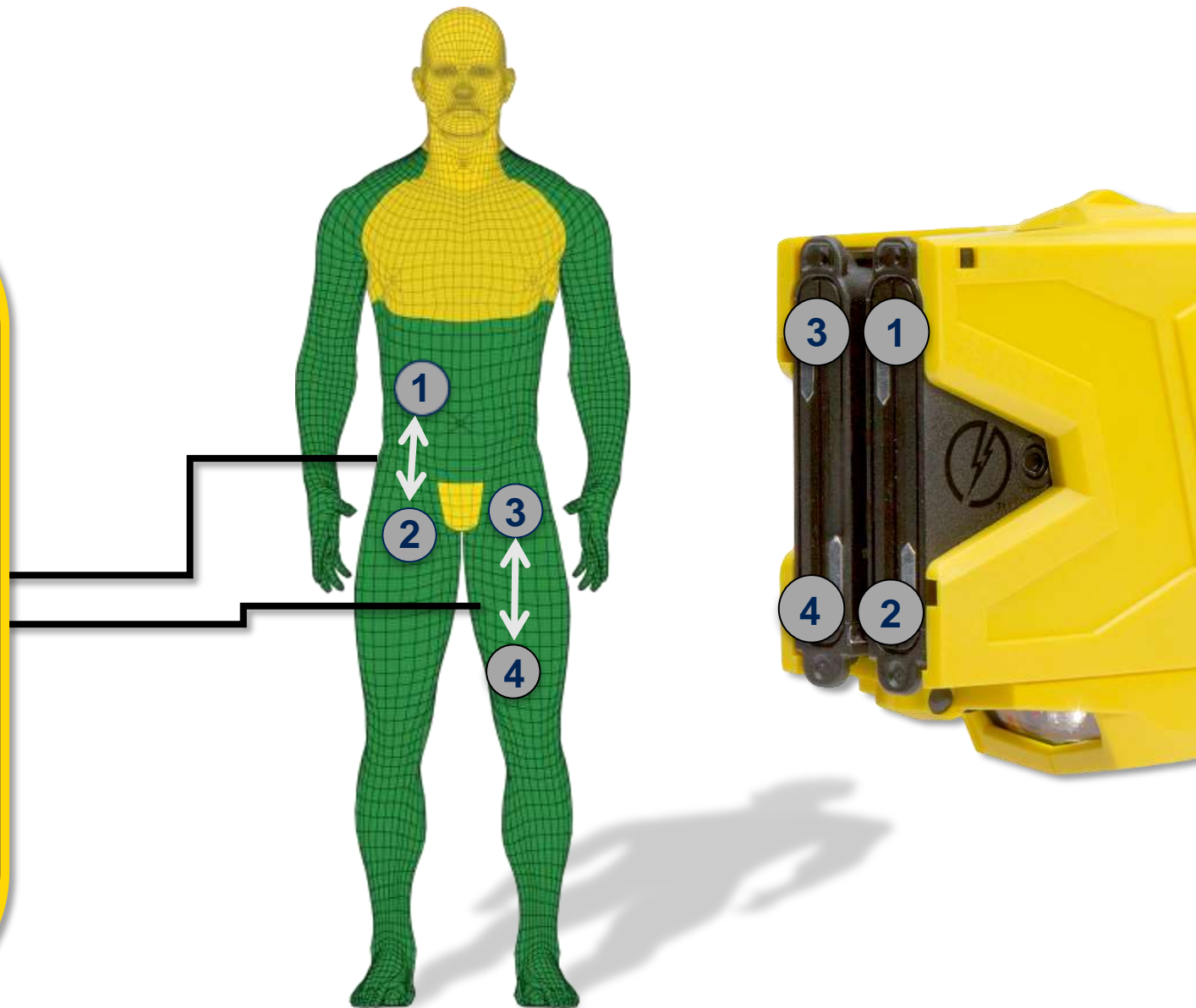



TASER Smart Cartridge



Smart Cartridge

- X2 CEW uses Smart cartridges which are different from TASER cartridges
- Contains small circuit board that communicates cartridge type (live vs. LS simulation), distance (15, 25) and status (loaded vs. deployed) to the X2 CEW
- Contains AFIDs similar to TASER cartridges

Smart Cartridge



15 ft

4.6m

Solid yellow blast doors

Clear shipping cover

Live cartridge



25 ft

7.62 m

Solid black blast doors

Clear shipping cover

Live cartridge



25 ft

7.62 m

Solid blue blast doors

Clear shipping cover

Live simulation (LS)

Non-conductive wire



Serial Number &
Expiration Date

Smart Cartridge Cut Away

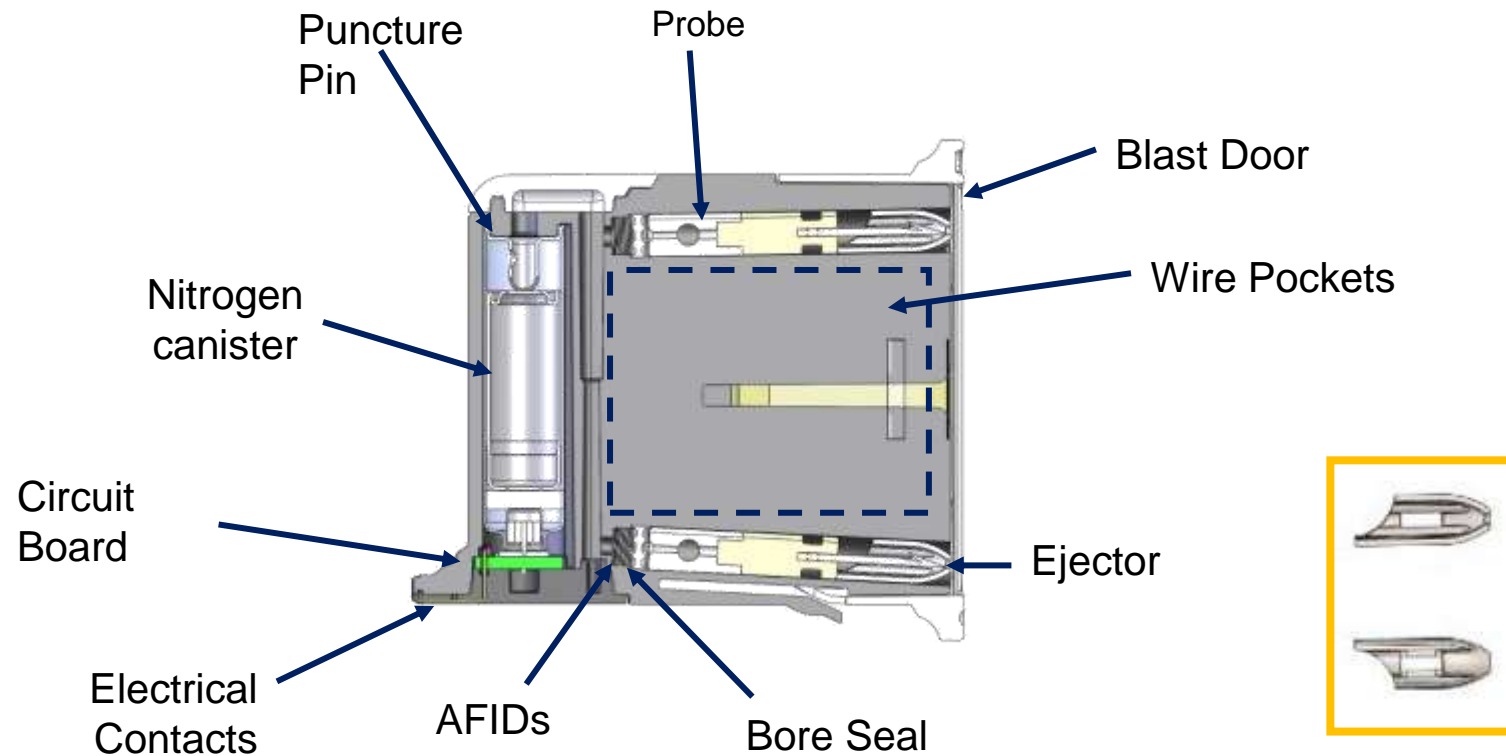

Deployment Methodology

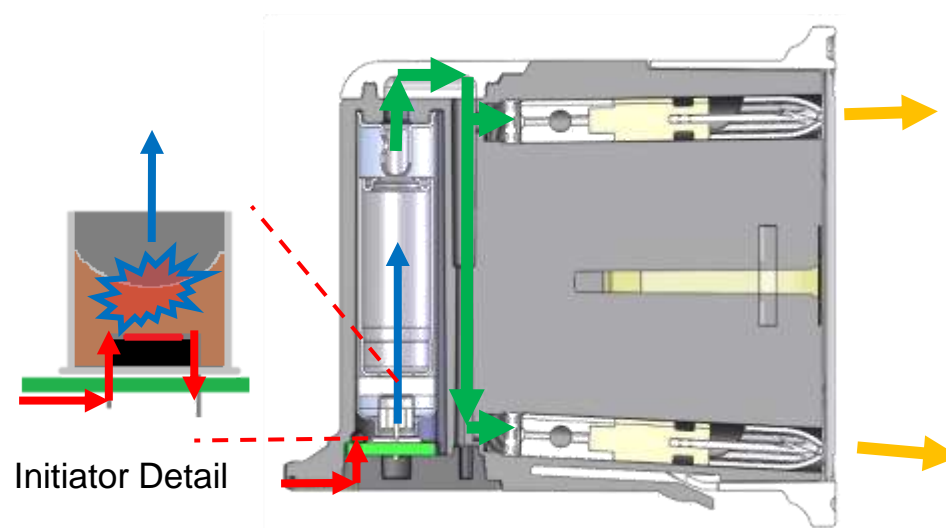

1

A low voltage high current signal is sent from the X2. This energy enters the initiator via the printed circuit assembly and heats up a bridge wire located in the initiator and immediately becomes hot causing the initiator material to ignite

4

The Blast doors are broken away from the front of the cartridge by the pressure of the ejectors; the darts, AFIDs, and seal are released and propelled toward the target

3

The escaping nitrogen gas expands down the gas channels creating pressure on the dart seals and darts

2

This ignition creates pressure to move the nitrogen canister towards the puncture pin causing the pin to puncture the nitrogen canister

Probe Spread

15 & 25 ft Smart Cartridges

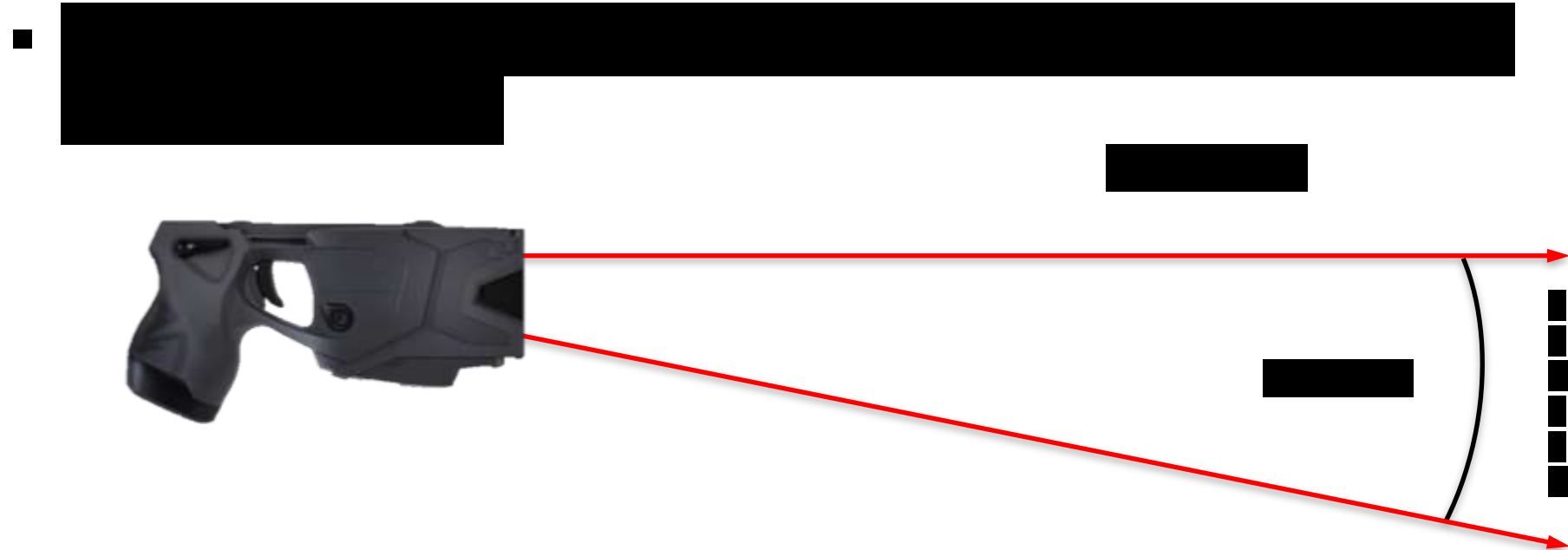

	(m)	2.7m	5.5m	7.6m
Target Distance	(ft)	9'	18'	25'
Spread	(in)	■	■	■
	(cm)	■	■	■

Deployment Distance Considerations

Deployments from [REDACTED] | [REDACTED]

- High hit probability BUT limited probe spread
- Split the beltline to increase effectiveness
- A minimum [REDACTED] probe spread is optimal

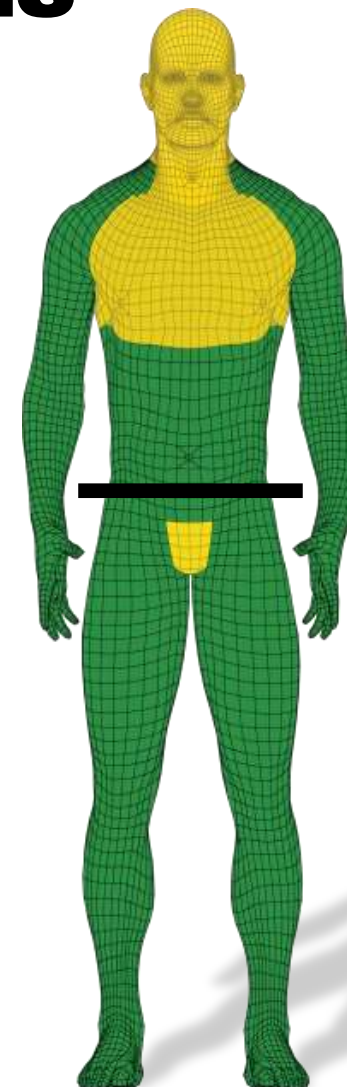

Smart Cartridge — Probe Dimensions

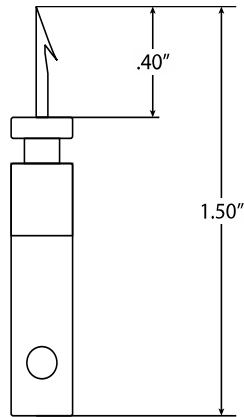

Standard
(15 ft)

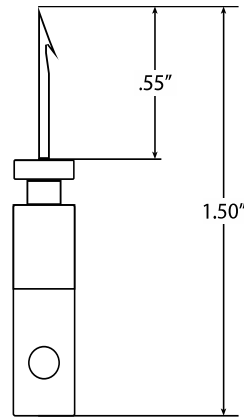

XP
(25 ft)

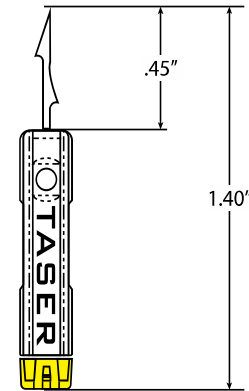

SP
(15 ft & 25 ft)

Probe Wires

- Copper Clad Steel with insulated coating
- [REDACTED]
- Inadvertent contact with wires or the probe during discharge can result in electrical shock
- TASER operator should advise officers to avoid wires during restraint
- Avoid crossing wires when multiple TASER CEWs are deployed

AFIDs



- Each cartridge contains 28 Anti-Felon Identification Tags (AFIDs) with the cartridge serial number printed on them

Inert Resettable Simulation

- Clear or red blast doors
- Appear on the CID as live cartridges
- No nitrogen, probes or wires
- For training only

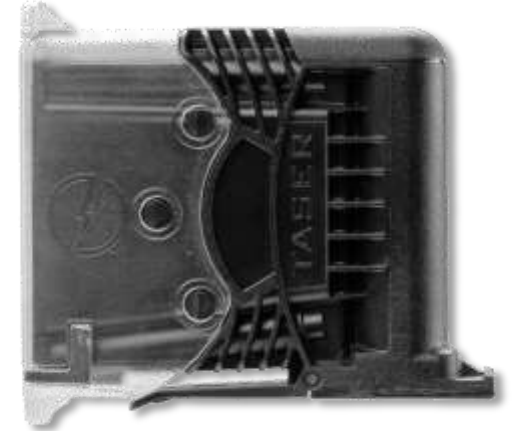

Loading Cartridges

- Hold the Smart cartridge at both ends of the blast doors while keeping all body parts away from the front
- Ensure safety switch is in the down (SAFE) position
- Point the X2 CEW in a safe direction
- Insert the protruding end into the deployment bay until it is seated



Basic Exposure to Water



Exposure to Water

WARNING!

- TASER CEWs exposed to significant moisture may experience unintentional discharge.
- Cartridges that are exposed to significant moisture must be disposed of in an ESD safe procedure*

Exposure to Water

WARNING!

DO NOT attempt to use a CEW that has been completely submerged in water. Instead:

1. Secure the CEW in the holster and remove the power source as soon as possible
2. Ensure that the safety switch is in the down (SAFE) position, remove the CEW from the holster and remove the cartridge(s) following the safe procedures outlined in the user manual and training material
3. Follow the RMA process to submit the CEW, cartridge(s) and battery to Axon Enterprise

Exposure to Water

WARNING!

The following procedure is for those CEWs exposed to a significant amount of moisture but not completely submerged in water.

1. Secure the CEW in the holster and remove the power source as soon as possible
2. Ensure the safety switch is in the down (SAFE) position, remove the CEW from the holster and remove the cartridge(s) following the safe procedures outlined in the user manual and training material
3. Wipe down all exposed surfaces including inside the cartridge bays and holster
4. Allow the CEW to air dry for 24 hours before proceeding
 - Warm dry air is preferred – do not use a hair dryer or other external heat source (e.g. microwave oven, etc.)

Exposure to Water

5. After 24 hours, verify that all components are completely dry; replace the power source
 - Wait one minute before proceeding to the next step.
6. Verify that the CEW is not getting warm or showing signs of short-circuiting
7. Point the front of the CEW away from you, place the safety switch in the up (ARMED) position and observe the CEW
 - If the CEW discharges without pulling the trigger, put the safety switch in the down (SAFE) position, remove the power source and return to Axon via the RMA process if it is still under warranty
 - If the CEW does not discharge without pulling the trigger, conduct three complete functionality tests for a full 5-seconds each to ensure the proper pulse rate and that the cycle stops at 5 seconds

Exposure to Water

8. If the CEW does not operate normally, ensure the safety switch is in the down (SAFE) position and remove the power source
 - Return the CEW to Axon via the RMA process if it is still under warranty.
9. If the CEW does function normally, ensure the safety switch is in the down (SAFE) position
 - Download and sync the CEW to ensure the internal time is correct.
 - Ensure that the three functionality tests were recorded properly in the download records.
 - Return the CEW to service.



CEW Smart Use Considerations

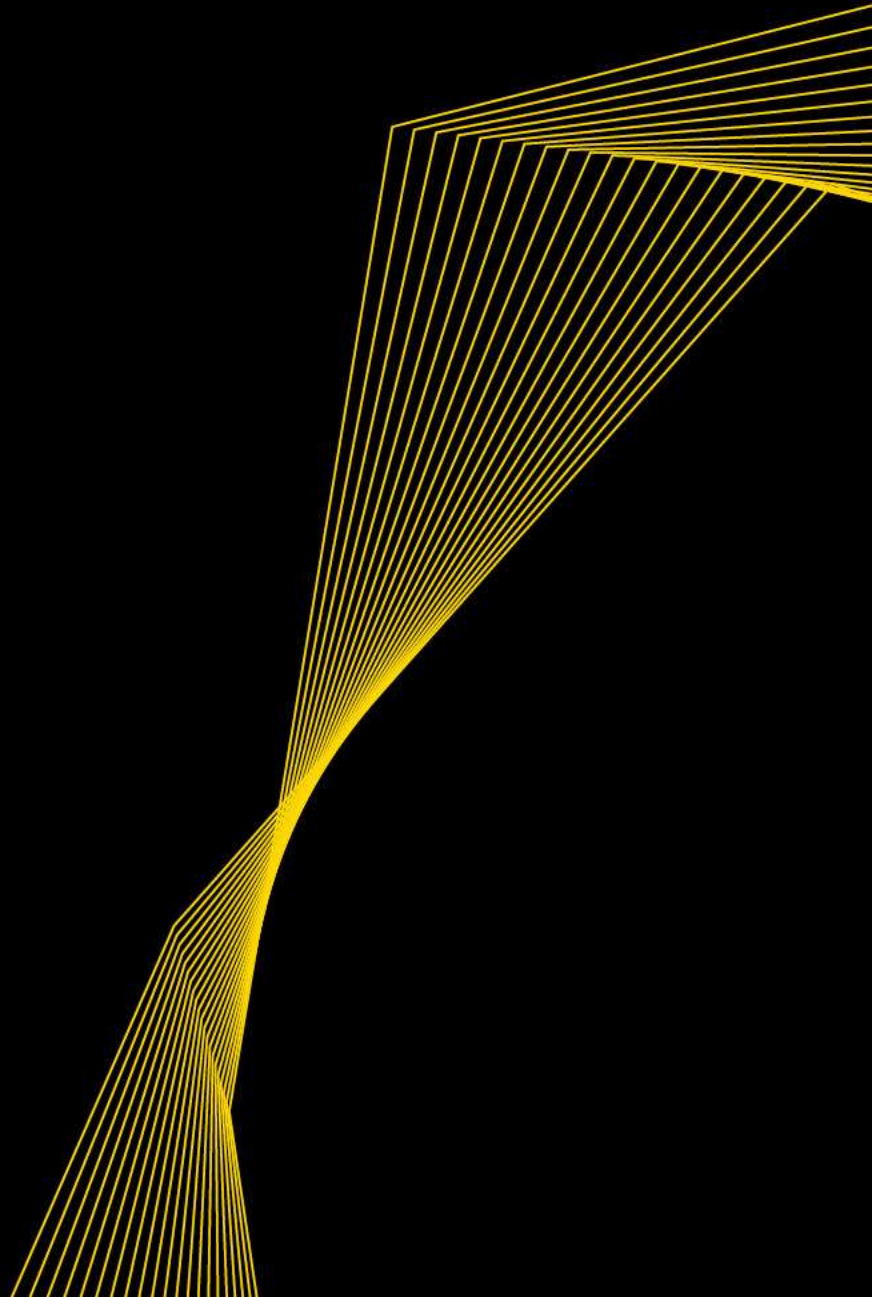

Different Use of Force Standards May Apply

- Remember, the 4th Amendment standard applies to uses of force by law enforcement officers against suspects until an arrest is completed
- Different federal standards apply to uses of force on pretrial detainees and convicted prisoners
- Additionally, the laws of your state may be more restrictive than federal standards
- It is important that you research and know all use of force standards applicable to you given your jurisdiction and position

Use of Force on Pretrial Detainees (detained but not convicted)

- Analyzed under the 14th Amendment Due Process Clause
- **Kingsley v. Hendrickson, 576 U.S. ____, 135 S.Ct. 2466 (2015):**
the use of force must be objectively reasonable, while considering legitimate interest to manage detention facility and maintain order, discipline and institutional security

Use of Force on Pretrial Detainees (detained but not convicted)

- **Factors to consider:**
 - Relationship between the need for use of force and the amount of force used
 - Extent of plaintiff's injury
 - Effort made to temper or limit amount of force
 - Severity of the security problem at issue
 - Threat reasonably perceived by the officer
 - Whether plaintiff was actively resisting

Use of Force on Convicted Prisoners

- Analyzed under the 8th Amendment's prohibition against cruel and unusual punishment
- **Whitley v. Albers, 475 U.S. 312 (1986):**
A use of force is unlawful if it amounts to an unnecessary and wanton infliction of pain – “whether force was applied in a good faith effort to maintain or restore discipline, or maliciously and sadistically for the very purpose of causing harm.”

Use of Force on Convicted Prisoners

- **Factors to consider:**
 - Relationship between the need for use of force and the amount of force used
 - Extent of plaintiff's injury
 - Extent of threat to safety of staff and inmates, as reasonably perceived by officials
 - Effort made to temper or limit amount of force





Tactical Considerations



Holster Carry Pros & Cons

Support Side

- +** Lower risk of drawing wrong weapon under stress
- +** Hip cross draw provides faster engagement on target
- +** Easier ID as a CEW by other officers
- Weapon Retention issues depending on DT training

Dominant Side

- +** Weapon Retention
- Higher Risk of weapon confusion
- Known incidents of shootings by mistaken weapon confusion

Refer to your department's tactical experts to make your own policy on how to carry, holster, and deploy the TASER CEW



BEST OUTCOME:

De-Escalate

UK TASER Options



Pre-cartridge Deployment

1. Officer arrival – subject sees device in holster
2. Effective officer communication
3. Drawing CEW
4. Arcing
5. LASER painting

Cartridge Deployment / [REDACTED]

6. Discharging CEW at subject
7. [REDACTED]
8. [REDACTED]

IN THE UK, MORE THAN 80% OF INCIDENTS ARE RESOLVED WITHOUT PROBES DEPLOYED

Subject with a Knife De-escalation Video

Video Learning Points

- Suicidal subject with a knife
- Officer maintained distance
- Officer showed empathy and built rapport

Subject with a Knife De-escalation Video



Tactical Considerations

- Have reasonable and appropriate force options available when practical
- Consider cover and distance tactics
- When practical:
 - have at least one back-up officer present to control/cuff under power
 - consider fall zone

Tactical Considerations

- [Redacted]
- [Redacted]
- [Redacted]

Probe Placement

Effectiveness is directly related to probe spread and probe location

- Greater probe spreads increase effectiveness
- Probe spreads typically are more effective if one probe is above and the other probe is below the beltline

Preferred Target Zone: Rear (when practicable)

Below neck (green zone)

- Large muscles
- Avoid head and neck

The back is the most preferred target area when reasonably practicable because it contains larger muscle groups and reduces the risk of hitting sensitive body areas

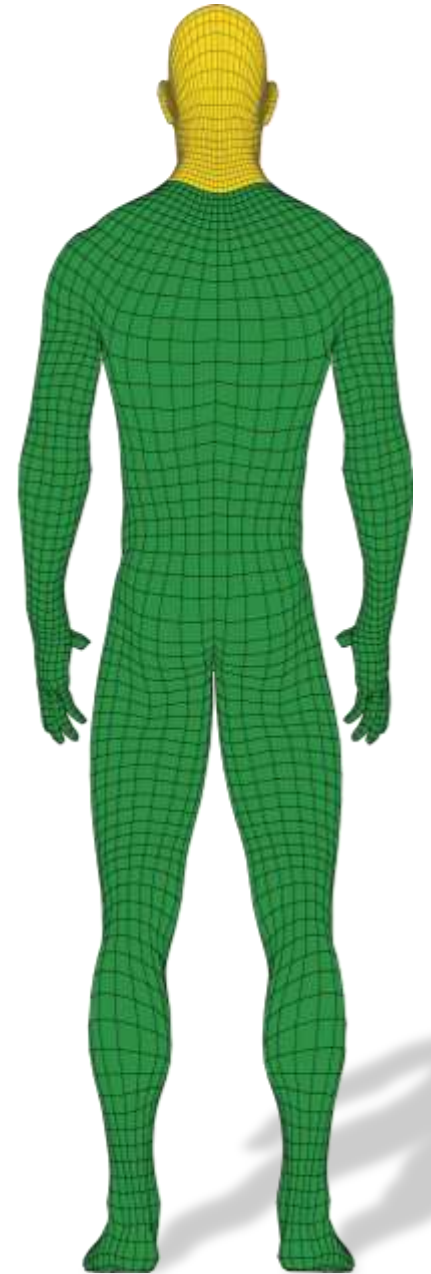

Preferred Target Zone: Front (when practicable)

Lower torso (green zone below chest)

- More effective
 - Larger muscles
 - Split the beltline
- Reduces risk of hitting sensitive body areas (see product warnings)
- Increases dart-to-heart safety margin distances
- Do not intentionally target head, throat, chest or genitals

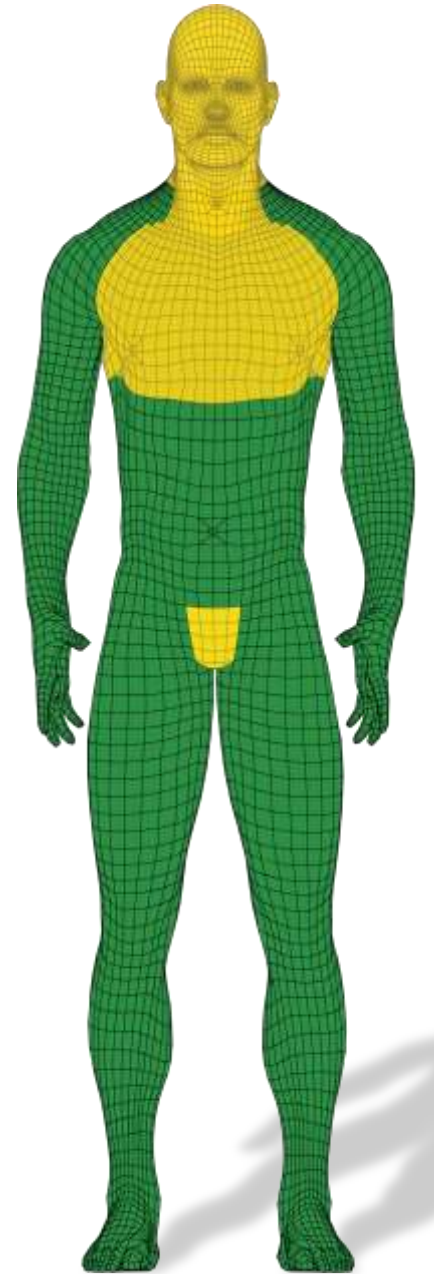

Probe Placement

- If practicable, deploy probes in preferred target zones of suspect's back:
 - Clothing fits tighter
 - Surprise factor
 - Stronger muscles – usually even more overwhelming
- Keep CEW in line with target
 - Vertical vs. Horizontal (subject lying down)
- Get both probes in preferred target zones
- Avoid intentionally targeting the CEW on sensitive areas of the body such as the head, throat, breast, chest or area of the heart, genitals, or known pre-existing injury areas without legal justification

TASER Conductive Targets

Conductive full-size targets available from TASER

- Preferred target zones
- Auditory feedback
- Allows targeting of lower body and legs
- Practice splitting the beltline
- Hip Check!



Increased Deployment Risk Examples

Subject:

- On an elevated position or platform
- Running or under momentum
- Operating vehicle or machinery
- [REDACTED]
- Obviously pregnant
- In water, mud, muck (drowning risk)
- Sensitive target areas
- Obviously frail or infirm
- Low body mass
- Probes in heart or chest area
- Extended, repeated, or continuous discharges

Injuries From Falls

NMI frequently causes subject to fall

- Falls are often uncontrolled and subjects are often unable to protect or catch themselves
- Falls, even from ground level, can cause serious injuries or death (especially on a hard surface)

Avoid Dangerous Falls

Video Learning Points

- Subject is running
- Subject unable to catch himself when TASER is deployed
- Could have resulted in serious injury



Be Careful of Distractions

- There are incidents/cases where officers have been accused of using excessive CEW exposures caused by distractions (including by nearby family members, bystanders, incident witnesses), stress, etc.
- Be alert to and avoid potential or occurring distractions that may result in unnecessary additional 5-second CEW cycles or extended exposures

Small Probe Spread Video

Video Learning Points

- Voluntary exposure with small probe spread on the back of the left leg
- Subject feeling the effects of the cycle, however still able to deliver effective baton strikes

Small Probe Spread Video



Close Quarters Video

Video Learning Points

- Small civil courtroom
- Suspect, victim and witness very close
- Bailiff deploys CEW at very close range
 - Initially forgot to arm the CEW
 - Avoids victim and witness
 - Suspect incapacitated and held until backup arrives
- Would baton or pepper spray have been a good option?

Close Quarters Video



Some Causes of Limited Effectiveness

- [REDACTED]
- [REDACTED]
- [REDACTED]
- [REDACTED]
- Low nerve or muscle mass
- Obese subject
- Wires break, touch each other, or fall on a conductive surface
- Operator error

Look for a Change in Behavior

- Look AND listen when evaluating the effectiveness of a CEW deployment
 - Watch the subject's reaction
 - Look for a change in behavior
- Loud arcing sound typically indicates NO connection
- Intermittent arcing typically indicates a poor connection such as a clothing disconnect

Intermittent Connection

Video Learning Points

- Voluntary exposure in conjunction with CEW training
- Volunteer is wearing a loose fitting shirt
- Spotters lower him immediately after the deployment, effectively closing the distance between the bottom probe and the volunteer's skin

Intermittent Connection



Ineffective Front Shot Video

Video Learning Points

- [REDACTED]
- OC deployment prior to CEW usage failed to achieve compliance
- No discernable effect from CEW
- Officers transitioned to hands-on

Ineffective Front Shot



Contingencies

- CEW may have limited or no effect
- No weapon system will operate or be effective all of the time
- A CEW or cartridge may not fire or be effective
- Advance to next cartridge and re-engage
- Employ other force options, other alternatives, or disengage

Flammability

- [REDACTED]

- [REDACTED]

- [REDACTED]

CAUTION

Test to ensure your personal defense spray is not flammable

Water Deployment Video

Video Learning Points

- Emotionally disturbed subject standing next to an in-ground swimming pool
- Firearm lying at his feet on pool deck
- Above and below the beltline shot placement
- Officers entered same body of water as the subject during the cycle

Water Deployment Video



Single Officer Deployment

Video Learning Points

- No immediately available handcuff/control officers
- Apparent effective CEW front shot
- What to do with the CEW immediately after the deployment?
 - Re-holster? Does your CEW holster maintain wire integrity?
 - Lay the CEW on the ground?
 - Await back-up if available?

Single Officer Deployment



Controlling/Cuffing Under Power

You can go hands on with the subject during the 5-second cycle without feeling the effects of NMI.

- Electricity generally follows the path of least resistance
- [REDACTED]
- [REDACTED]
- Cuffing under power can reduce the need for repeated or extended CEW exposures

Control and Cuffing under power Video

Video Learning Points

- Subject with a knife
- Several Use of Force options, back-up/cover officers
- TASER CEW deployed to subjects back area
- Controlled and cuffed under power

Control and Cuffing under power Video



Inmate Under Power Video

Video Learning Points

- Consideration given to splitting the belt line
- Handcuff/Control officers readily available
- Good verbal communication

Inmate Under Power Video



Suicidal Subjects

- Follow your agency's policy and basic officer safety rules/training when dealing with suicidal subjects
- CEWs may be an effective way to deal with suicidal subjects
- Establish deadly-force cover as needed and available

Suicidal Subjects

The following video shows:

- A subject with a knife
- Several officers on scene
- Subject states
“Do society a favor... shoot me.”



Suicidal Subjects

Discussion Points

- Several Use of Force options back-up/cover officers
- Clear commands in attempt to de-escalate
- EMS on location



Drive Stun

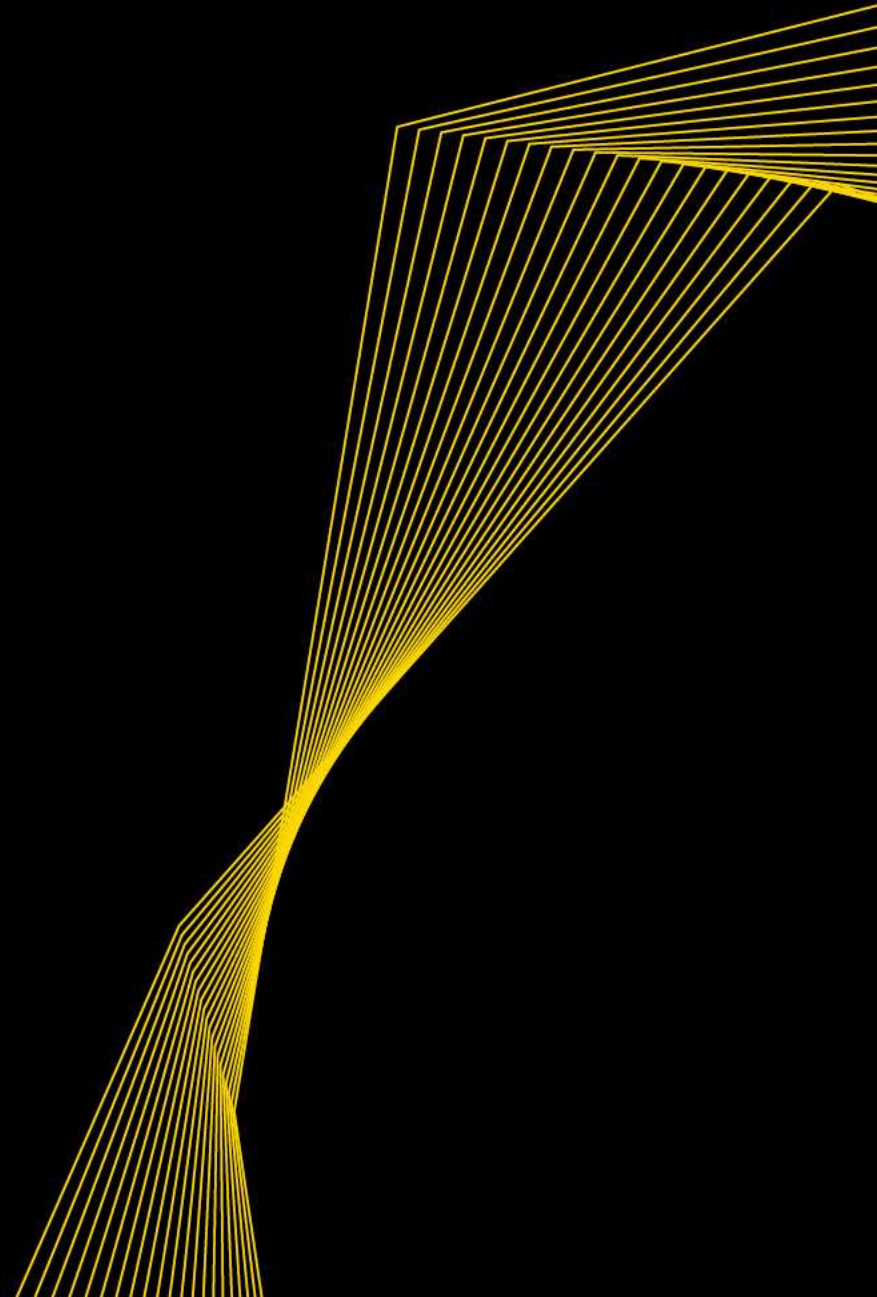

Drive Stun Considerations

- **Avoid using CEW drive stuns *except*:**
 - [REDACTED]
 - [REDACTED]
 - [REDACTED]
- Do not repeat drive stuns if compliance not achieved
- Do not use drive stuns if pain is unlikely to gain compliance due to mind-body disconnect (psychotic episode) or increased pain tolerance (drugs/alcohol)

Probe Deployment vs Drive Stun

Probe deployments are more desirable/effective than drive stuns (other than 3-point deployments)

- NMI vs. pain compliance
- Can be applied from a safer distance
- Usually require fewer cycles

Drive Stun

- Use care when applying the drive stun near the neck or groin (yellow)
- Avoid areas that can be easily crushed like the trachea (red), the back of the neck, and the genitals
- Follow agency policy



Drive Stun

- To use the drive stun without deploying the probes, remove the live cartridge (X26/P), or depress the ARC switch (X2)
- If not effective, transition to alternative force option
- Do not hold on to a live cartridge while applying a drive stun. If cartridge gets within approximately 2 inches of the CEW, it may deploy



Animals



Effects on Animals

If CEW's are used on animals, consider having animal control stand by to apply a restraint during the cycle

Animal Use Video



Police/Military K-9 Caution

- If K-9 bites probe or between probes during CEW deployment, the dog may receive a shock
- An electrical shock to a K-9 may result in a hesitant, hesitating, or bite adverse K-9
- Develop procedures and train K-9 handlers and CEW operators on this issue



Post Incident

An abstract graphic on the right side of the slide, consisting of numerous thin, parallel yellow lines that converge and then diverge, creating a sense of depth and movement. The lines are arranged in a way that suggests a funnel or a path that narrows and then widens again.

Post Incident

- Record incident from officer's point of view
- Fully document
 - Subject's threats, behaviors, and actions
 - Each application of force
 - Each CEW trigger pull or 5-second discharge
 - Each injury or alleged injury

Post Incident

- Consider using your radio to establish record of significant events with dispatch time logs (call in):
 - Immediately at end of CEW use
 - Immediately upon subject being handcuffed
- Monitor subject's medical condition and report any changes
- As with any use of force, if subject is unresponsive, initiate EMS/CPR protocols

Probe Removal

Probe Removal Policy Considerations

- May officers remove probes?
 - Common probe penetration
 - Sensitive location probe penetration
 - Uncommon probe penetration
- Proper handling of removed probes
 - Bio-hazard
 - Evidentiary value

Probe Removal Follow-up

- Note if probes penetrated skin
- Photographs of impact site and injuries
- Medical follow-up
- Ensure probe and barb are intact

Considerations for Handling Used Probes (Field Deployments)



Factors to be considered include:

- Unanticipated probe-related injury
- Probe in sensitive area
- Deeper embedment of probe due to movement, body position, or pressure on probe
- Evidence collection, proper storage, and retention*

Considerations for Handling Used Probes (Field Deployments & Training)



- Treat probes that have penetrated the body as contaminated needles (use gloves)
- [REDACTED]
- Carefully place used probes sharp-tip first into either a sharps container or into the cartridge side wire pocket container, secure in place, and place in a secure location where no one will accidentally touch probes

Evidence Collection

Consider (consistent with legal requirements and agency policy):

- Photographing injuries, probe impact or energy arcing sites or contact points
- Collecting cartridge, probes, AFIDs
- TASER CEW Evidence Collection and Analysis Course



X2 Evidence Sync

Axon Evidence (Evidence.com)

A decorative graphic on the right side of the slide, consisting of numerous thin, parallel yellow lines that curve and fan out from a central point towards the top right corner.

Axon Evidence (Evidence.com) & Evidence Sync

- The following slides will offer a very brief overview of Axon Evidence (Evidence.com) and Evidence Sync.
- For a full tutorial on Axon Evidence (Evidence.com) and Evidence Sync, visit:
<https://www.axon.com/training/resources>

Axon Evidence (Evidence.com)

A program offered by Axon Enterprise that makes it easy for agencies of any size to manage CEW related material, collect, transfer, manage, retrieve and share any form of digital evidence

- ❑ Cloud storage solution
- ❑ For CEW firing records including TASER cam footage.
- ❑ Allows for CEW device assignment

Axon Evidence Event Log

TASER X2 CEW Log 2018-11-12 2213 

ADD ID

ADD CATEGORY



DOWNLOAD	FLAG	REASSIGN	AUDIT TRAIL	DELETE
▶ Armed		1 Events Duration 12s		11 Jun 2018 11:56:45 -04:00
▶ Armed		1 Events Duration 4s		11 Jun 2018 11:57:00 -04:00
▶ Armed		1 Events Duration 11s		11 Jun 2018 11:57:06 -04:00
▶ Armed		0 Events Duration 1s		11 Jun 2018 11:58:18 -04:00
▶ Armed		0 Events Duration 10s		11 Jun 2018 11:59:39 -04:00
▶ Armed		0 Events Duration 2s		11 Jun 2018 11:59:53 -04:00
▶ Armed		0 Events Duration 3s		11 Jun 2018 12:00:31 -04:00
▶ Armed		0 Events Duration 22s		11 Jun 2018 12:00:57 -04:00
▶ Armed		0 Events Duration 9s		11 Jun 2018 12:05:06 -04:00
▶ Armed		0 Events Duration 9s		11 Jun 2018 12:06:46 -04:00
▶ Armed		1 Events Duration 4s		12 Nov 2018 23:54:17 -05:00
▶ USB		1 Events Duration 2s		13 Nov 2018 00:01:24 -05:00
▶ Armed		0 Events Duration 1s		13 Nov 2018 00:02:17 -05:00
▼ Armed		0 Events Duration 2s		13 Nov 2018 00:02:19 -05:00
Safe		Battery: 72% Temperature: 33°C		13 Nov 2018 00:02:21 -05:00
▼ Armed		4 Events Duration 21s		13 Nov 2018 00:02:28 -05:00
▶ Trigger		Battery: 72% Duration: 5s		13 Nov 2018 00:02:30 -05:00
▶ Arc		Battery: 72% Duration: 1s		13 Nov 2018 00:02:37 -05:00
▶ Arc		Battery: 72% Duration: 1s		13 Nov 2018 00:02:39 -05:00
▶ Trigger		Battery: 72% Duration: 5s		13 Nov 2018 00:02:41 -05:00
Safe		Battery: 72% Temperature: 33°C		13 Nov 2018 00:02:49 -05:00
▶ Armed		0 Events Duration 3s		13 Nov 2018 00:02:52 -05:00
▶ USB		2 Events Duration 27s		13 Nov 2018 00:03:04 -05:00

« Prev 1 2 3 4

MANAGE EVIDENCE ACCESS

 INSIDE MY AGENCY None added >

OUTSIDE MY AGENCY None added >

 No Location Added 

METADATA

Assigned To:  Cousins, Lamar (0837)

Recorded On: 

Uploaded On: Nov 13, 2018 12:13 AM -05:00

Uploaded By:  Cousins, Lamar (0837)

Deletion Scheduled For: Unscheduled

File Size: 14.8 KB

SOURCE

Serial: X30002FWK

Model: TASER X2

CASES

No associated cases

CATEGORIES

What is Evidence Sync?

- Evidence Sync is a software offered by Axon that allows agencies to:
 - Access TASER CEW firing data for the X26, X26P and X2
 - Update firmware on CEWs
 - Automatically time sync CEWs
 - Assign TASER CEWs in conjunction with your agency's Evidence.com account

Quarterly Downloads

- TASER Training recommends that these downloads be conducted on a quarterly basis, at a minimum
- This recommendation is based on the following overall goals:
 - Verify that the CEW has the most recent firmware installed.
 - Check the overall condition and functionality of the CEW; including spark rate, power source level and presence of any fault icons
 - Validate that recommended pre-shift or daily functionality tests are being conducted via the CEW firing records
 - Retention of CEW firing records

Offline Mode

The screenshot displays the Evidence Sync Offline Mode interface. At the top, it says 'EVIDENCE SYNC Offline 3.15.98'. On the left, there is a 'Download Queue' section for a 'TASER X2' device with serial number 'X30002FWK' and firmware '04.037'. A 'PDF report' button is visible below the device information. The main area is titled 'Logs' and shows a table of events with filters for 'From: 11:00 1 June 2015' and 'To: 01:00 13 November 2018'. The table columns are '#', 'Local Time', 'Event', 'Cartridge Info', 'Duration', 'Temp', and 'Batt %'. The events listed include 'Armed', 'Safe', 'Armed', 'Safe', 'Armed', 'Trigger', 'Arc', 'Arc', 'Trigger', 'Safe', 'Armed', 'Safe', 'USB Connected', and 'Time Sync'.

#	Local Time	Event	Cartridge Info	Duration	Temp	Batt %
235	12 Nov 2018 21:02:17	Armed	C2 : 25' Standard		33°C	72%
236	12 Nov 2018 21:02:18	Safe	C1 : 25' Standard C2 : 25' Standard	1s	33°C	72%
237	12 Nov 2018 21:02:19	Armed	C1 : 25' Standard C2 : 25' Standard		33°C	72%
238	12 Nov 2018 21:02:21	Safe	C1 : 25' Standard C2 : 25' Standard	2s	33°C	72%
239	12 Nov 2018 21:02:28	Armed	C1 : 25' Standard C2 : 25' Standard		33°C	72%
240	12 Nov 2018 21:02:30	Trigger	C1 : Deployed	5s		72%
241	12 Nov 2018 21:02:37	Arc	C1 : Deployed C2 : 25' Standard	1s		72%
242	12 Nov 2018 21:02:39	Arc	C1 : Deployed C2 : 25' Standard	1s		72%
243	12 Nov 2018 21:02:41	Trigger	C2 : Deployed	5s		72%
244	12 Nov 2018 21:02:49	Safe	C1 : Deployed C2 : Deployed	21s	33°C	72%
245	12 Nov 2018 21:02:52	Armed	C1 : 25' Standard C2 : Deployed		34°C	72%
246	12 Nov 2018 21:02:55	Safe	C1 : 25' Standard C2 : Deployed	3s	33°C	72%
247	12 Nov 2018 21:03:04	USB Connected				
248	12 Nov 2018 21:03:10	Time Sync	12 Nov 2018 21:03:10 to 12 Nov 2018 21:03:10			
249	12 Nov 2018 21:03:31	Time Sync	12 Nov 2018 21:03:31 to 12 Nov 2018 21:03:31			

Offline Mode: Does not require an Evidence.com account or an internet connection. The Offline Mode will allow users to download firing data and videos to their local storage location. Users cannot access CEW Pulse graphs in Offline Mode or upload evidence to an Evidence.com account.

Online Mode

SYNC Uploads Help

EVIDENCE SYNC Online 3.15.98 Cousins, Lamar (0837) Sign out

Upload Queue

Devices

X3000FWK
Cousins, Lamar (0837)
Firmware: 04.037
PDF report

Folders

Search

Favorites

- Desktop
- Downloads
- Recent Items

Libraries

- CameraRoll
- Documents
- Music
- Pictures
- SavedPictures
- Videos

Computer

- C:
- T:

Logs

Filters: OFF From: 11:00 1 June 2015 To: 01:00 13 November 2018 Events: All

#	Local Time	Event	Cartridge Info	Duration	Temp	Batt %	Graphs
235	13 Nov 2018 00:02:17	Armed	C2 : 25' Standard		33°C	74%	
236	13 Nov 2018 00:02:18	Safe	C1 : 25' Standard C2 : 25' Standard	1s	33°C	72%	Graphs
237	13 Nov 2018 00:02:19	Armed	C1 : 25' Standard C2 : 25' Standard		33°C	72%	
238	13 Nov 2018 00:02:21	Safe	C1 : 25' Standard C2 : 25' Standard	2s	33°C	72%	Graphs
239	13 Nov 2018 00:02:28	Armed	C1 : 25' Standard C2 : 25' Standard		33°C	72%	
240	13 Nov 2018 00:02:30	Trigger	C1 : Deployed	5s		72%	Graphs
241	13 Nov 2018 00:02:37	Arc	C1 : Deployed C2 : 25' Standard	1s		72%	Graphs
242	13 Nov 2018 00:02:39	Arc	C1 : Deployed C2 : 25' Standard	1s		72%	Graphs
243	13 Nov 2018 00:02:41	Trigger	C2 : Deployed	5s		72%	Graphs
244	13 Nov 2018 00:02:49	Safe	C1 : Deployed C2 : Deployed	21s	33°C	72%	
245	13 Nov 2018 00:02:52	Armed	C1 : 25' Standard C2 : Deployed		34°C	72%	
246	13 Nov 2018 00:02:55	Safe	C1 : 25' Standard C2 : Deployed	3s	33°C	72%	
247	13 Nov 2018 00:03:04	USB Connected					
248	13 Nov 2018 00:03:10	Time Sync	13 Nov 2018 00:03:10 to 13 Nov 2018 00:03:10				
249	13 Nov 2018 00:03:31	Time Sync	13 Nov 2018 00:03:31 to 13 Nov 2018 00:03:31				

PDF Report

Online Mode: Requires an internet connection and allows an agency to upload Evidence to their Evidence.com account. Online mode allows users to take full advantage of all of the abilities of Evidence Sync such as firmware updating, access CEW Pulse graphs, etc.

Event log

The Event log tracks events. An event begins when the safety is moved to the up (ARMED) position and ends when it is moved to the down (SAFE) position. The Event log also stores deployment events for each cartridge bay: cartridge type, deployment status (whether the cartridge actually deployed or not), trigger pull vs. ARC switch activation, duration of cycle, date, and time.

The Event log also stores system configuration change events: (e.g. if the date, time, time sync, LASER, or flashlight settings are viewed or changed).



Taser Information

Dept.	Master Instructor Training
Serial	X300007H
Model	TASER X2
Firmware Version	Rev: 04.032
Device Name	X300007H
Health	Good

Report Generated by

Name	Cousins, Lamar
Badge ID	001
Local Timezone	Mountain Standard Time (UTC -06:00)
Generated On	30 Aug 2017 06:07:49

Device (X2)

Seq #	Local Time [dd:mm:yyyy H:mm:Sec]	Event [Event Type]	Cartridge Information [Bay:Length in feet/status]	Duration [Seconds]	Temp [Degrees Celsius]	Batt Remaining [%]
1	13 Jul 2017 08:13:53	Armed	C1: 20' Standard C2: 20' Standard		28 28	75 75
2	13 Jul 2017 08:13:54	Trigger	C1: Deployed	1		75
3	13 Jul 2017 08:13:54	Trigger	C2: Deployed	1		75
4	13 Jul 2017 08:13:58	Safe	C1: Deployed C2: Deployed	0:0	28 28	75 75
5	13 Jul 2017 13:28:16	Armed	C1: 20' Standard C2: 20' Standard		28 28	75 75

Sync PDF Event Log



TASER Information

Dept. TASER Training Pro
Serial X30002FWK
Model TASER X2
Firmware Version Rev. 04.037
Device Name X30002FWK
Health Good

Report Generated by

Name Cousins, Lamar
Badge ID 0837
Local Timezone Eastern Standard Time (UTC -0500)
Generated On 13 Nov 2018 00:22:53

Dates from : Sun Nov 11 11:00:00 2018 to : Tue Nov 13 01:00:00 2018

Device (X2)

Seq #	Local Time [DD:MM:YYYY hh:mm:ss]	Event [Event Type]	Cartridge Info [Bay: length in feet/status]	Duration [Seconds]	Temp [Degrees Celsius]	Batt Remaining [%]
230	12 Nov 2018 23:54:17	Armed	C1: 25' Standard C2: 25' Standard		27	72
231	12 Nov 2018 23:54:21	Arc	C1: 25' Standard C2: 25' Standard	1		72
232	12 Nov 2018 23:54:21	Safe	C1: 25' Standard C2: 25' Standard	4	29	72



Basic Drills

Live Fire Drills

Practical Exercises

Conclusion and Written Examinations

A decorative graphic on the right side of the slide, consisting of numerous thin yellow lines that converge and then fan out, creating a dynamic, abstract shape.

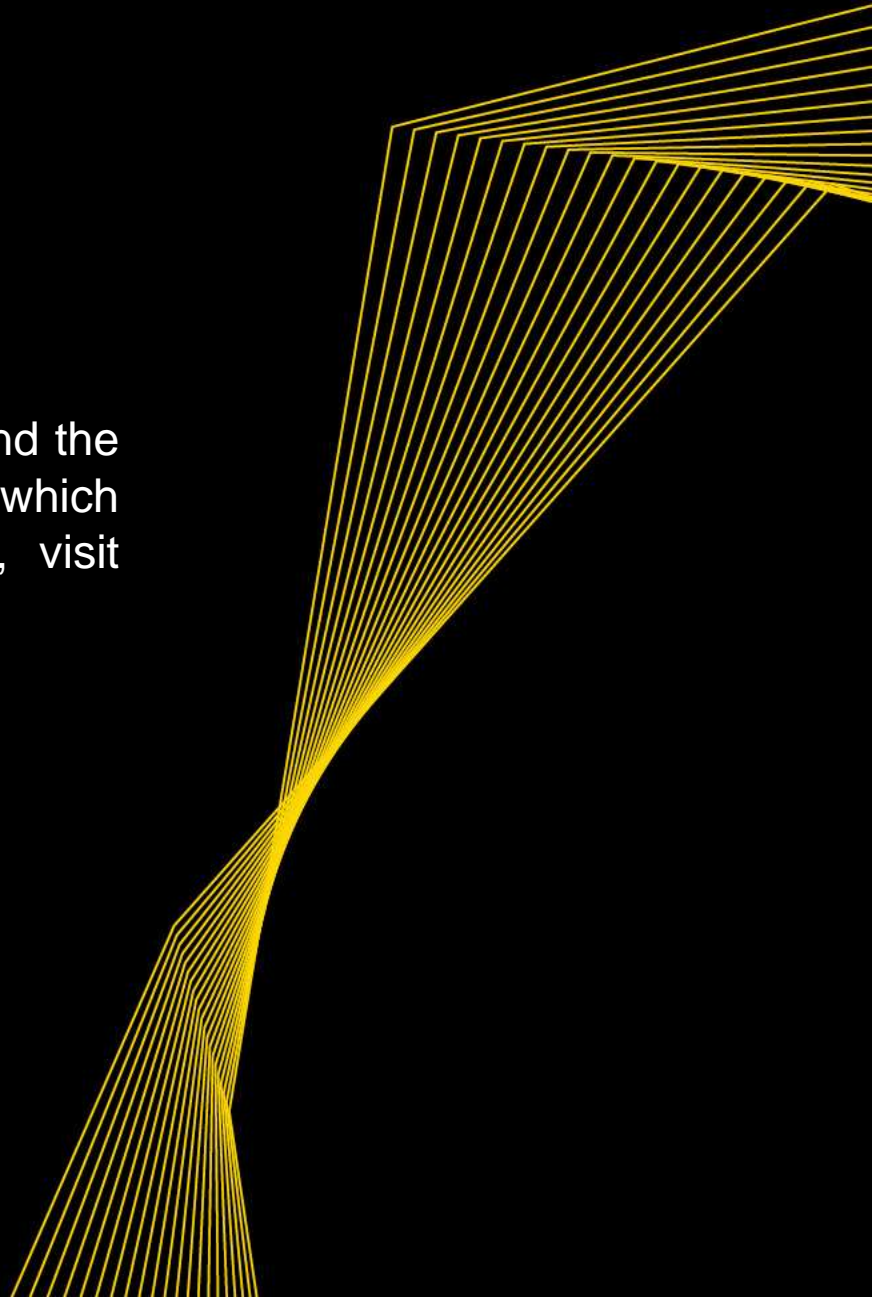

Axon, X2, X26, X26P, M26, TASER, TASER 7, Smart Cartridge, SPPM, and the “Bolt within Circle Logo” are trademarks of Axon Enterprise, Inc., some of which are registered in the US and other countries. For more information, visit www.axon.com/legal. All rights reserved. © 2019 Axon Enterprise, Inc.

PowerPoint is a trademark of Microsoft Corporation